

DEFEM MESH TRAYS

CATALOGUE 2023

Mesh Tray system for demanding applications

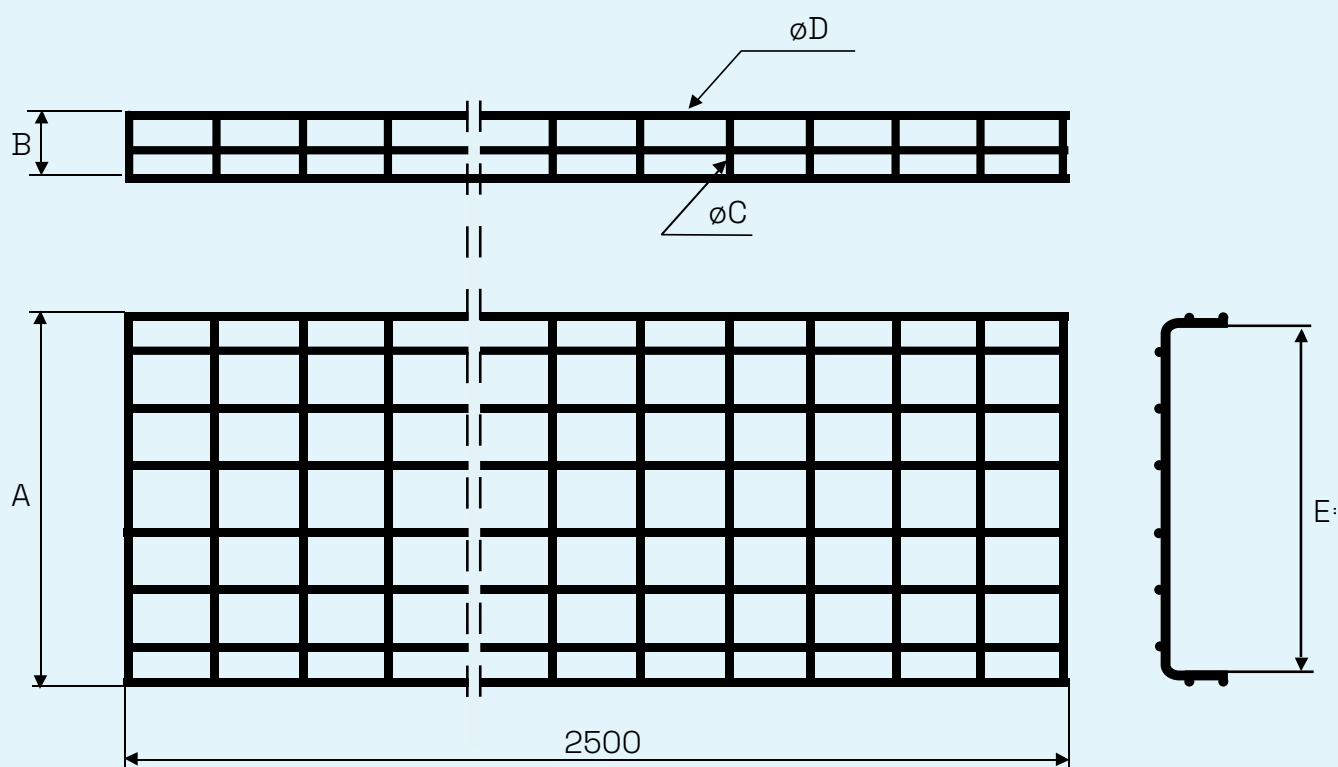

Creating clever, uplifting solutions, together with our clients for almost 100 years. Reimagined in June 2021 – for the coming century.

Looking ahead to the next century, we are reinventing ourselves – as Wibe Group – bringing together four of the world's leading cable management brands as a new independent company to offer a complete, innovative range of cable ladders, cable trays and mesh trays – for applications ranging from commercial buildings to extreme demanding industrial environments.



Cable support is the fundament of our total power and network offer

With a powerful and extensive range of Cable Support products from Wibe Group, our customers can feel confident that there is always a strong backbone to build their solutions around – whether applied for a huge data centre or a wind power park supporting an entire community.

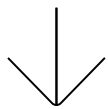

Cable Support is an essential ingredient in the total Wibe Group offer, from power distribution to building management.



In the late 1920s the founders of Wibe, Mr Wikstrand and Mr Berg, realized the advantages of using a ladder horizontally as well as vertically. And that the horizontal ladder was ideal for carrying cabling. Since then, the product range has grown to include a vast amount of ladders, trays and accessories suitable for a variety of applications and environments.

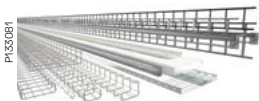

Our Cable Support range contains all necessary elements for a complete solution – mesh trays, cable trays and cable ladders along with a wide variety of accessories.

P135/035

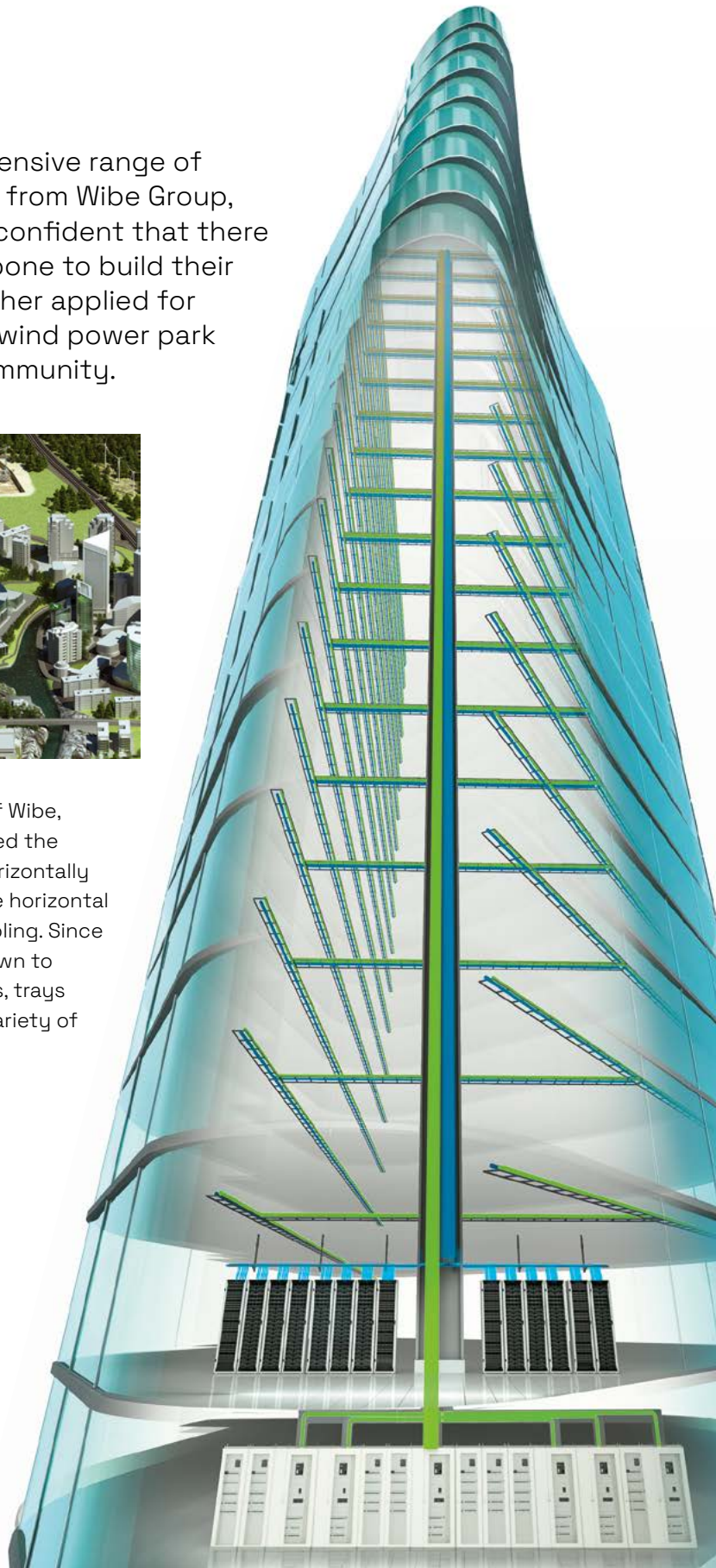

Content

Presentation	5
Installation summary.....	22
Steel mesh trays	24
Electro-galvanized/Pre-galvanized.....	24
CLX ³ Click suspension.....	34
Hot-dip galvanized.....	35
Stainless steel AISI 304L.....	42
Stainless steel AISI 316L.....	43
Technical information.....	51
Corrosion classes	53
Surface treatments.....	54
Potential balancing.....	55
Electro-magnetic compatibility EMC	57
Quality.....	58
Loading capacity.....	59
Use and installation	61
Mounting instructions.....	109
Index	116
Reference number overview	116



Defem Mesh Trays

Every construction needs a strong backbone

Defem high-end mesh trays are part of our integrated, complete cable support offer for the routing of power, data and control cables. The mesh trays, accessories and support systems are excellent for light, medium and heavy duty applications. With a variety of surface treatments, the total assortment is suitable for non-aggressive in-door environments like offices and IT-centres, as well as for demanding applications such as food industries and harsh outdoor environments like windmills, tunnels and offshore.

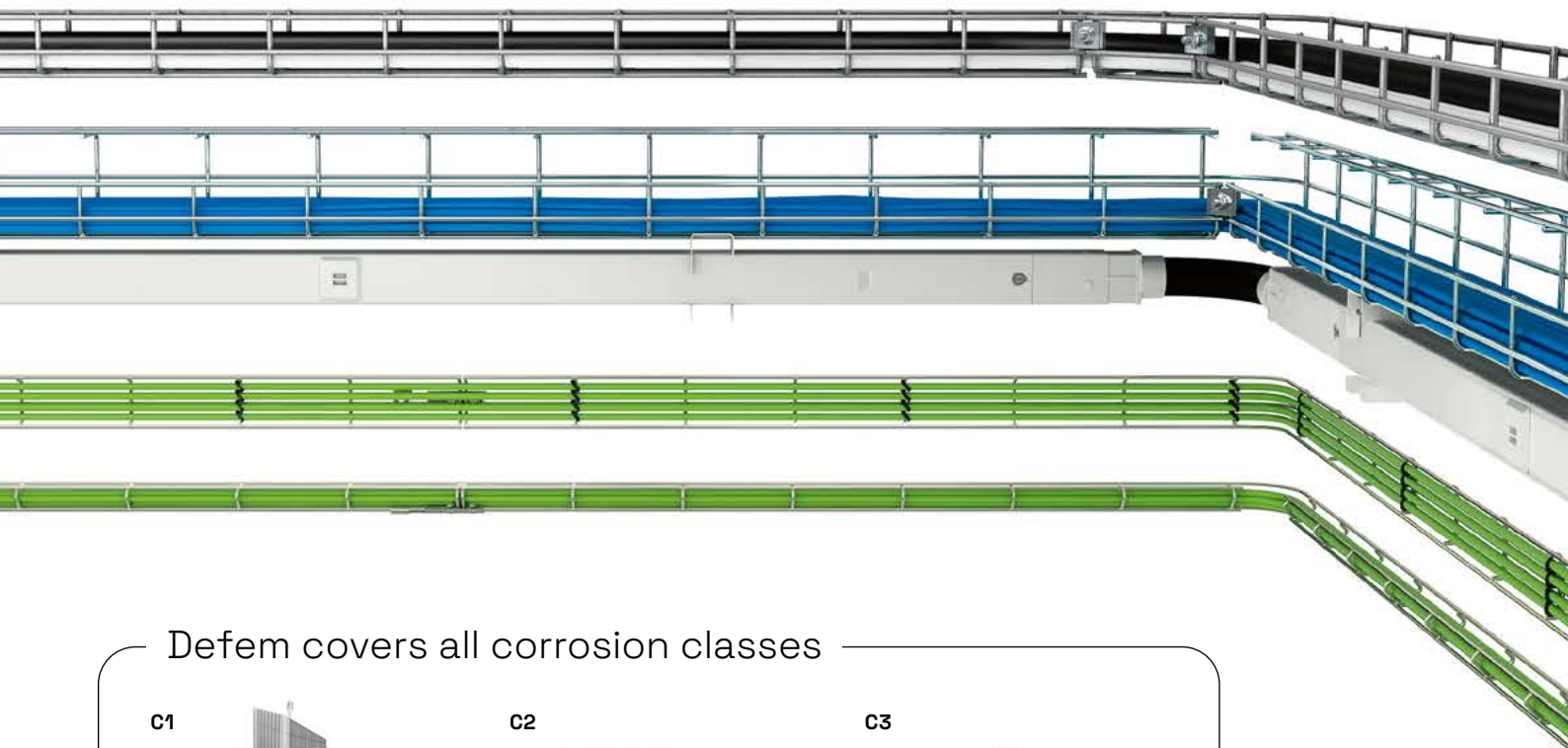

Defem covers all corrosion classes

C1



Electro-galvanized

For heated facilities with low exposure to corrosion, such as hotels and offices.

C2



Pre-galvanized

For partly outdoor environments with low exposure to corrosion, for example warehouses and parking garages.

C3



Hot-dip galvanized

For urban and light industrial areas with average environmental corrosion, such as breweries and dairies.

C4



Hot-dip galvanized

For areas with high levels of environmental corrosion, humidity and airborne pollution such as industrial and coastal areas, chemical plants, dockyards.

C5-I



Stainless steel AISI 304L

For areas with almost permanent high levels of humidity and airborne pollution, such as chemical and heavy industries, tunnels and dockyards.

C5-M



Stainless steel AISI 316L

For areas with almost permanent high levels of humidity, airborne pollution and salt, such as purifying plants and offshore.

Read more about corrosion classes on page 68

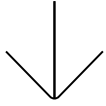

Decades of product development, hundreds of worldwide cases, an extensive range of complementary products for any installation, high-end system at a competitive total lifecycle cost.



Defem standard Mesh Trays 11

Robust, easily assembled mesh trays with unbeatable capacity and support distances. Suitable for a number of applications, for example large-scale data centres.

Defem custom-made Mesh Trays 13

Mesh trays that can be delivered custom-made for various needs and conditions.

Defem special purpose Mesh Trays 15

Uniquely shaped mesh trays for the toughest requirements regarding hygiene and sanitation – the cabling is kept in place even when exposed to high pressure cleaning.

Defem Mini Mesh Trays 15

Ideal mesh trays for tricky installations in narrow spaces. Just bend, shape and cut to fit.

Accessories and benefits 16

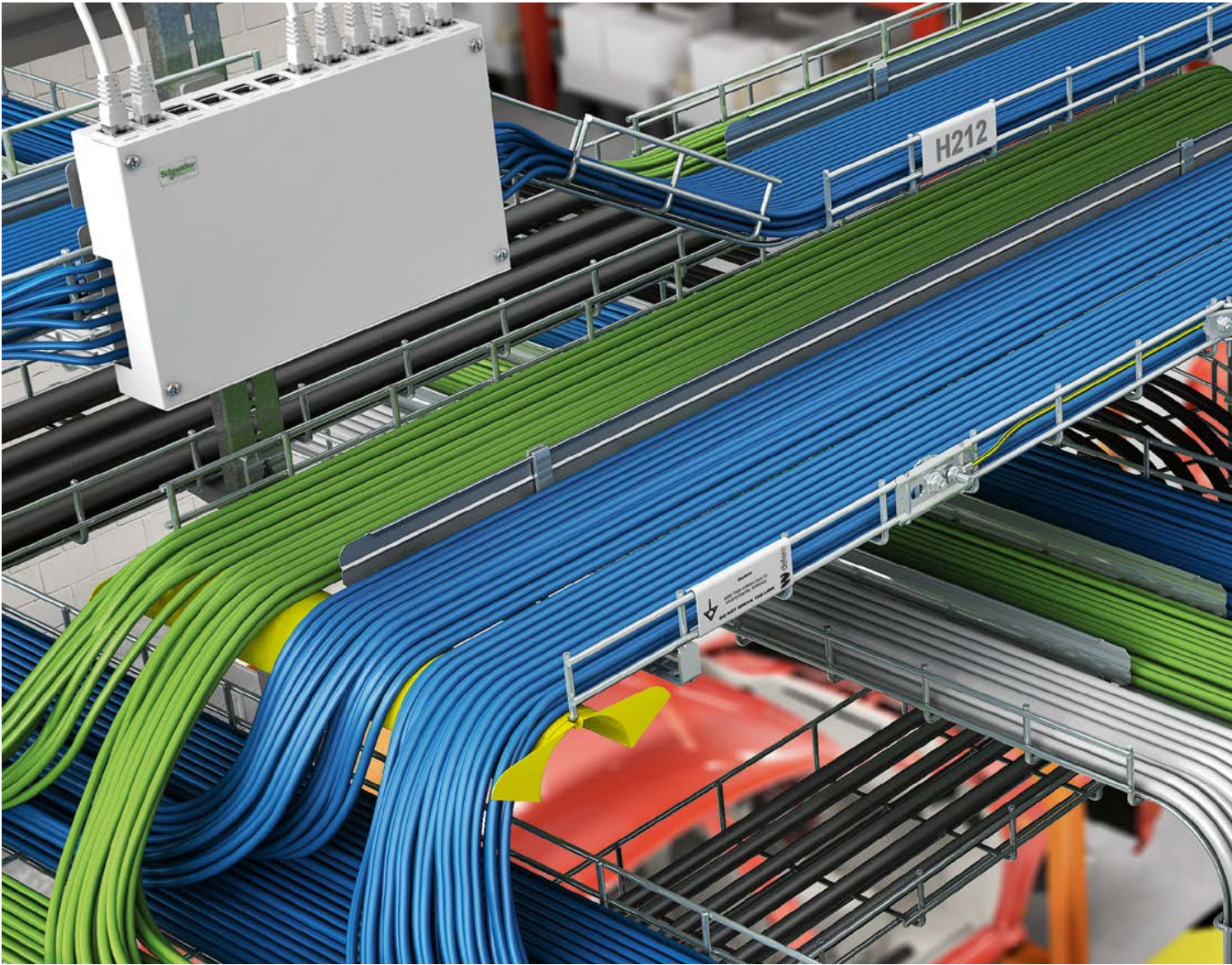

Step up to impressive capacity and endless opportunities

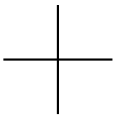

Defem mesh trays can also be delivered as pre-cut parts or custom-made kits.

Miles of cables in all directions – no tangle, no mess. A variety of shapes, sizes and innovative accessories ensures a tidy, safe and flexible mesh tray installation in every type of environment.

The Defem mesh tray range supports wall-mounted, floor-laid and ceiling-suspended installations. Bends, raisers and reducers can easily be formed on site from length material elements.

Defem mesh trays provide a flexible, safe and easily installed solution. Thanks to the uniquely shaped rounded wire ends, as well as the smooth and strong welding points,

the mesh trays comply with all safety requirements for installers and cables. Also, the wire diameter and size allows higher safety working-load values than any comparable products on the market. Add to that a variety of surface treatments to choose from, and you have a complete solution ready to take on any challenge.

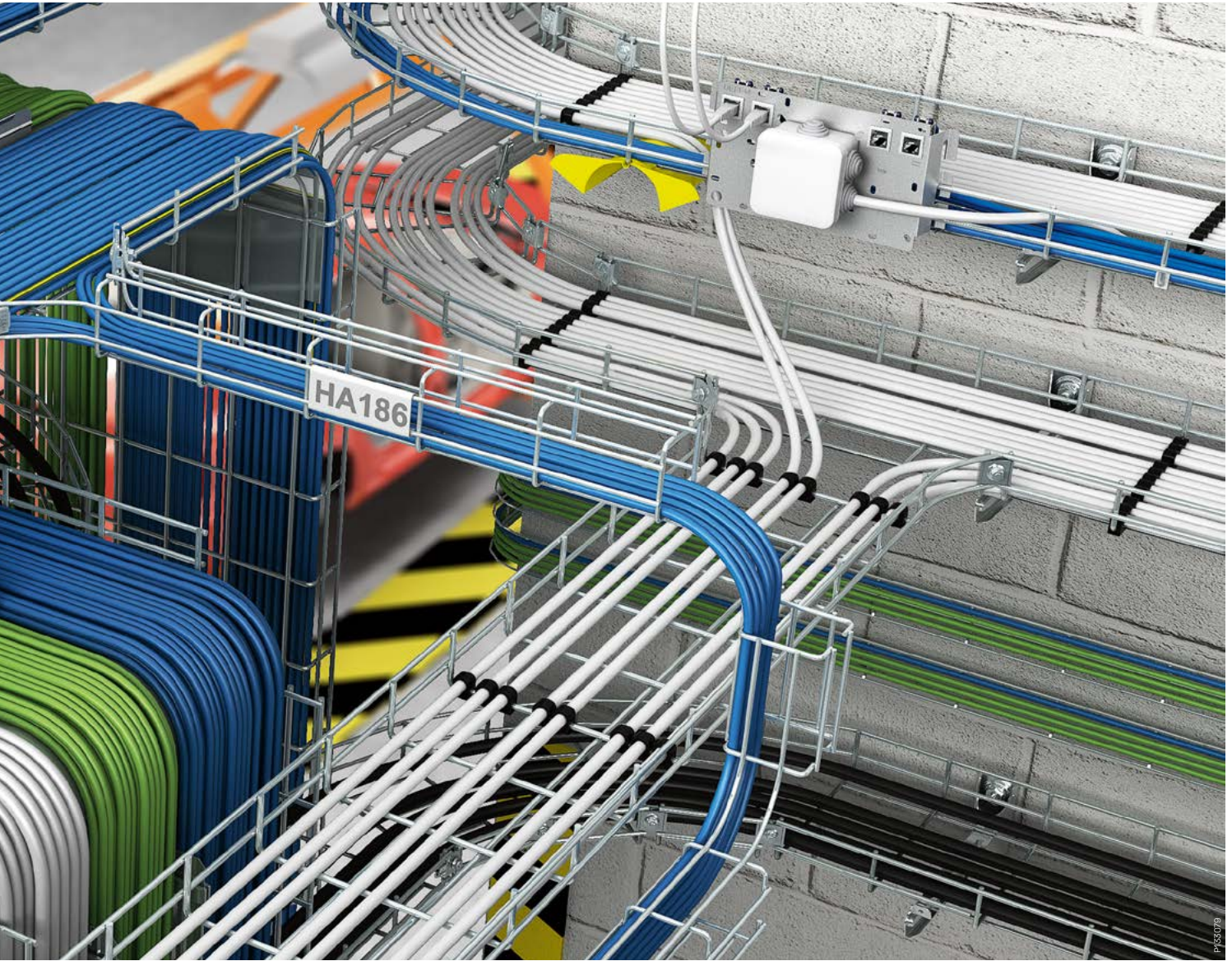

Clear marking
Just snap the clip onto the two side-wires of the mesh tray.



Accessory holders
Use any of our accessory holders dedicated for a variety of boxes and outlets. Snap it onto the mesh tray wires and tighten the grips.



Robust brackets
Mount the brackets right onto the wall or on ceiling- suspended pendants.



Fasten the cables
Keep the cables in place with Cable clips. Oil and UV- resistant.



Strong and secure
Screw-fitting ensures a very robust installation with secure earthing and equipotential bonding over time.



Separate the cables
Easy to bend by hand, no tools are needed. Can be mounted continuously both on length material and bends.

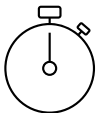

No need to order accessories like bends, reducers and raisers. Form them easily on site from length material.



Defem standard Mesh Trays

- the fast track to reliability

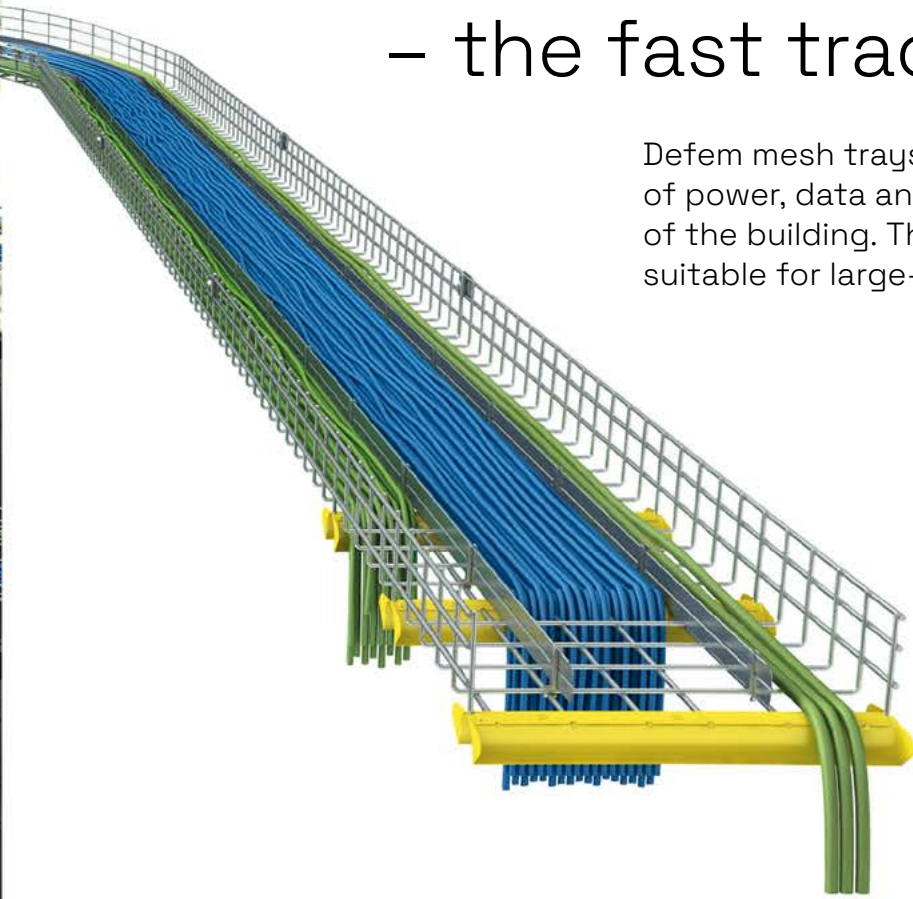

Defem mesh trays provide reliable and safe transport of power, data and control cables to every corner of the building. The solution is strong, flexible and suitable for large-scale applications.

Whether a small industry or a large-scale airport, enabling trouble-free distribution of power and data is essential. Safe operation, easy maintenance and a minimum of interruptions, are requirements that call for a dependable and secure cable support system. The Defem range also includes support for easily accessible power distribution underneath the floor. Together with the flexible mesh trays for network distribution in the ceiling, the entire data centre installation is fully equipped, strong, and conveniently adjusted to any application.

A wide range of dimensions

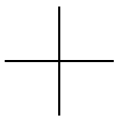
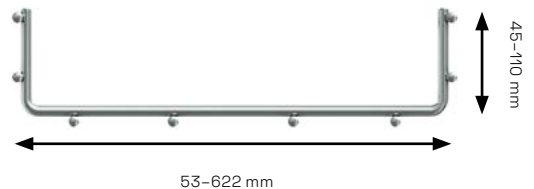

Product features

Well-rounded edges, along with smooth and strong welding points protect hands and cables from being damaged by sharp edges.

The open structure allows airflow and prevents cables from overheating.



Zone cabling

Fittings for zone cabling are part of the Wibe Group total offer for data and telecom.

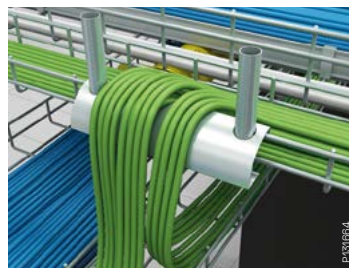

Side radius limiter

For a protective and smooth distribution of gentle fibre cables.

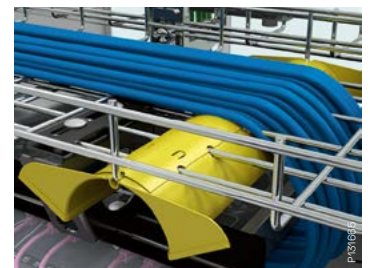

Fibre management

The radius limiter protects sensitive cables from being bent at a too sharp an angle, which may cause reduced performance.



Defem custom-made Mesh Trays – flexibility at its best

Special applications require special products. The Defem mesh tray is easy to cut and bend for any configuration. But if you need a series of similar tailored parts for your installation, let us do the cutting and shaping for you. No waste of material or time.

In quite a few projects there is a repeated need for mesh trays of a special design. We can deliver the mesh trays specially adapted to these needs, as pre-cut parts, or as complete, custom-made kit solutions.

Custom-making is not only about having the mesh tray cut in a certain manner. It is also about optimizing both performance and cost-efficiency to the special conditions that may occur, understanding the customer's need.

We have a long time of experience from many projects around the world and can provide custom-made adaptations for rigorous hygienic requirements, infrastructure in aggressive environments, and much more.



Ready-made kits - simplifies your work on site

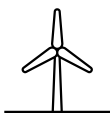
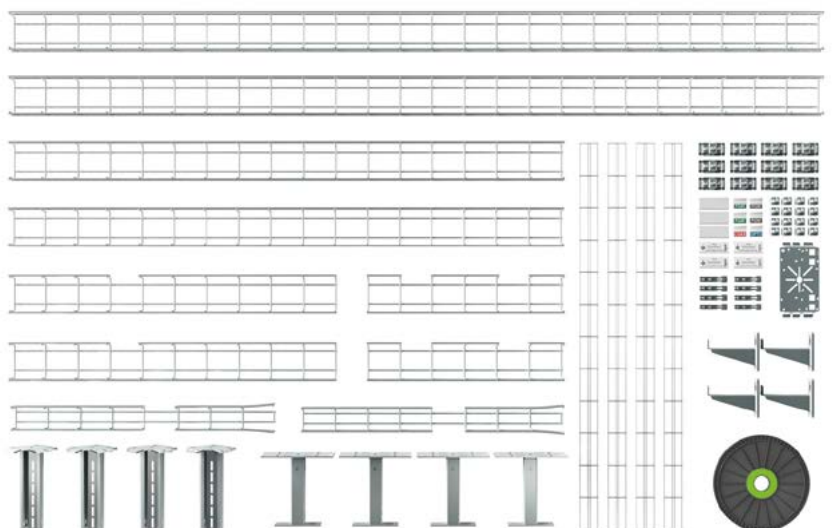

Offshore windpower turbines are subject to the harshest climate. Every detail must endure the tough conditions.

16

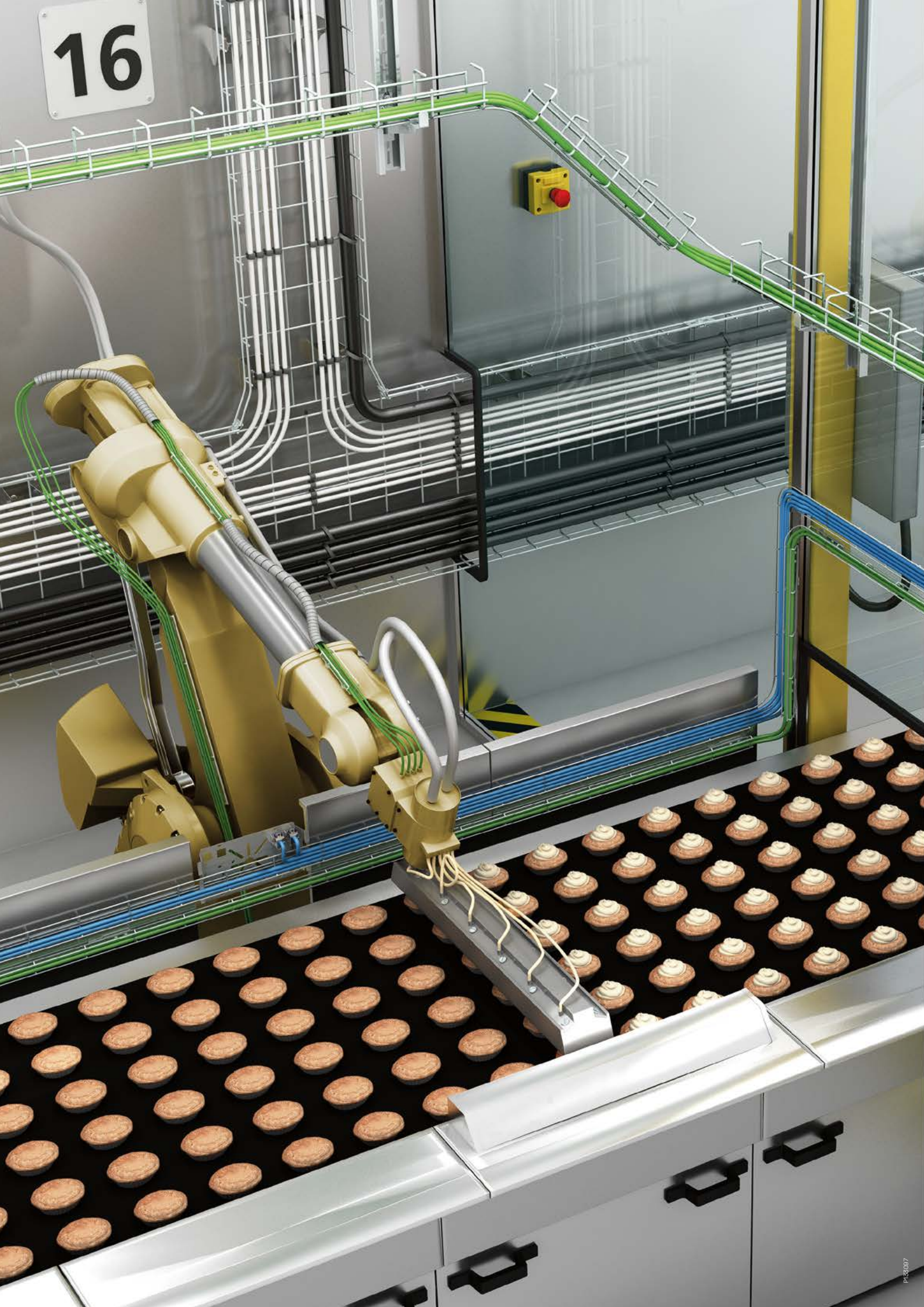

Defem special purpose Mesh Trays – when hygiene is key



You can let loose the high-pressure washing system with no worries. Defem mesh trays withstand the most rigid sanitary regulations and the non-bundled cables will stay in place during cleaning.

The food and beverage industry has the most rigorous regulations on hygiene and sanitation. Every part of the installation has to endure high-pressure washing and harsh detergents. The ingenious shapes of the C-, G- and Z-mesh trays provide excellent protection of and access to the cables. Thanks to the smooth and high-quality welding points with no cavities, undesired substances will be prevented from accumulating.

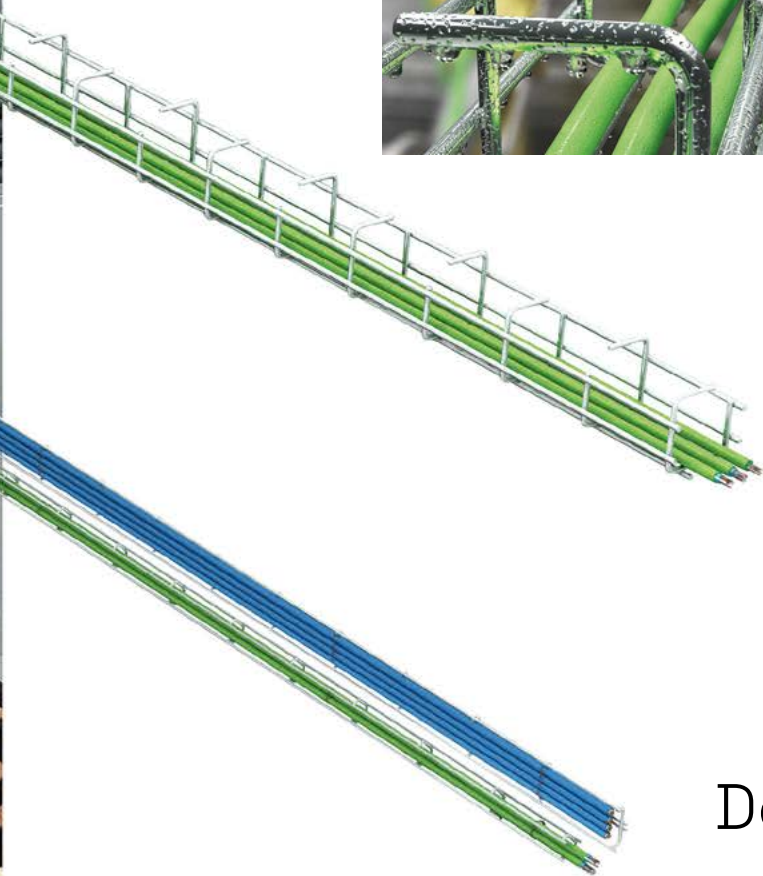

Dimensions



C-Mesh tray,
120x100 mm



G-Mesh tray,
75x95 mm



Z-Mesh tray,
75x75 mm

Defem Mini Mesh Trays – flexibility in detail



Measure and cut the mini mesh tray into the desired length and fasten it with our dedicated accessories – and you are done.

The mini mesh trays offer the fastest way to route all types of small cables. Though modest in size, the mini mesh trays can endure any type of high-pressure water or air cleaning. The Mini mesh B30-D also provides an excellent protection of impact to cables in tough environments.

Dimensions



Mini Mesh B30-D,
30x24 mm



Mini Mesh B30-U,
46x15 mm



Mini Mesh B30-I,
60x6 mm

Accessories and benefits

Marking clip, Equipotential Bonding

For clear, visible information, just snap the plastic marking clip onto the mesh tray. Available in English, Swedish and German.



Accessory holder

Accessory holders without holes or with a universal hole pattern for easy mounting of various boxes and outlets. The holder can be mounted in different directions and angles on a mesh tray. The holder is tightened to the mesh tray by closing the grip around the wires.

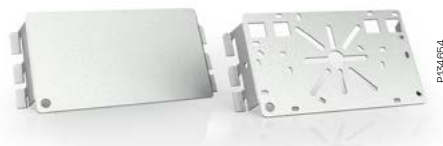

Fitting

Fittings for joining mesh trays. Can also be used as wall brackets or fastened onto a machine or similar. Mounted over the centre wires, it can also serve as a carrier of lighting fittings.



Floor support

Floor support for all mesh trays, for example underneath a raised floor. Adjustable 215–370 mm. The upper and lower part can be adjusted in a 90 degree angle.

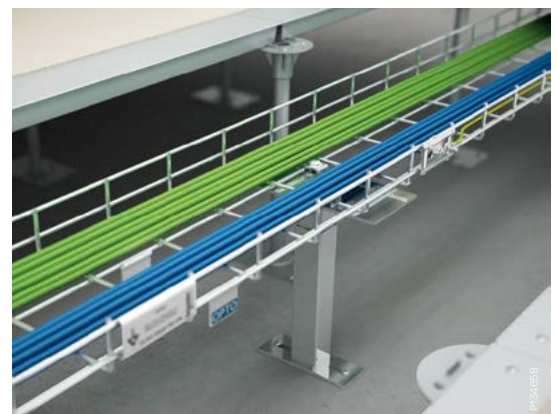



Separating plates

The plane separation plate can be mounted continuously both on length material and in bends with the support of plate holders. No tools are needed. Easy to bend by hand.

The L-shaped separating plate can be fastened onto the mesh trays by bending the flaps around the transversal wires.

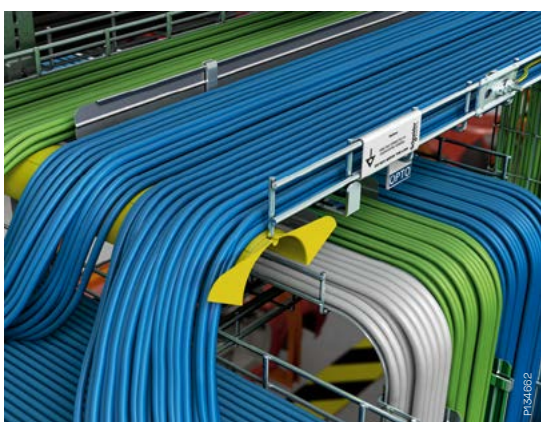

Bend plate, Radius limiter, Side radius limiter

The bend plate is made of aluminium and used for smooth bending of cables when changing levels. The steel radius limiters protect the cables from being bent at too narrow an angle.



Brackets for Canalis KBA and KBB busbars

The use of brackets will further stabilize and strengthen the installation. Just fasten the Canalis busbar to the mesh tray, and attach the dedicated Canalis lighting fittings underneath.



Brackets for hygiene installation

Stainless steel brackets for firm and secure mounting of mesh trays onto walls and pendants. A mounting distance of 100 mm from the wall enables easy cleaning. Especially suitable for environments that must endure rigid sanitary requirements, such as the food and beverage industry.



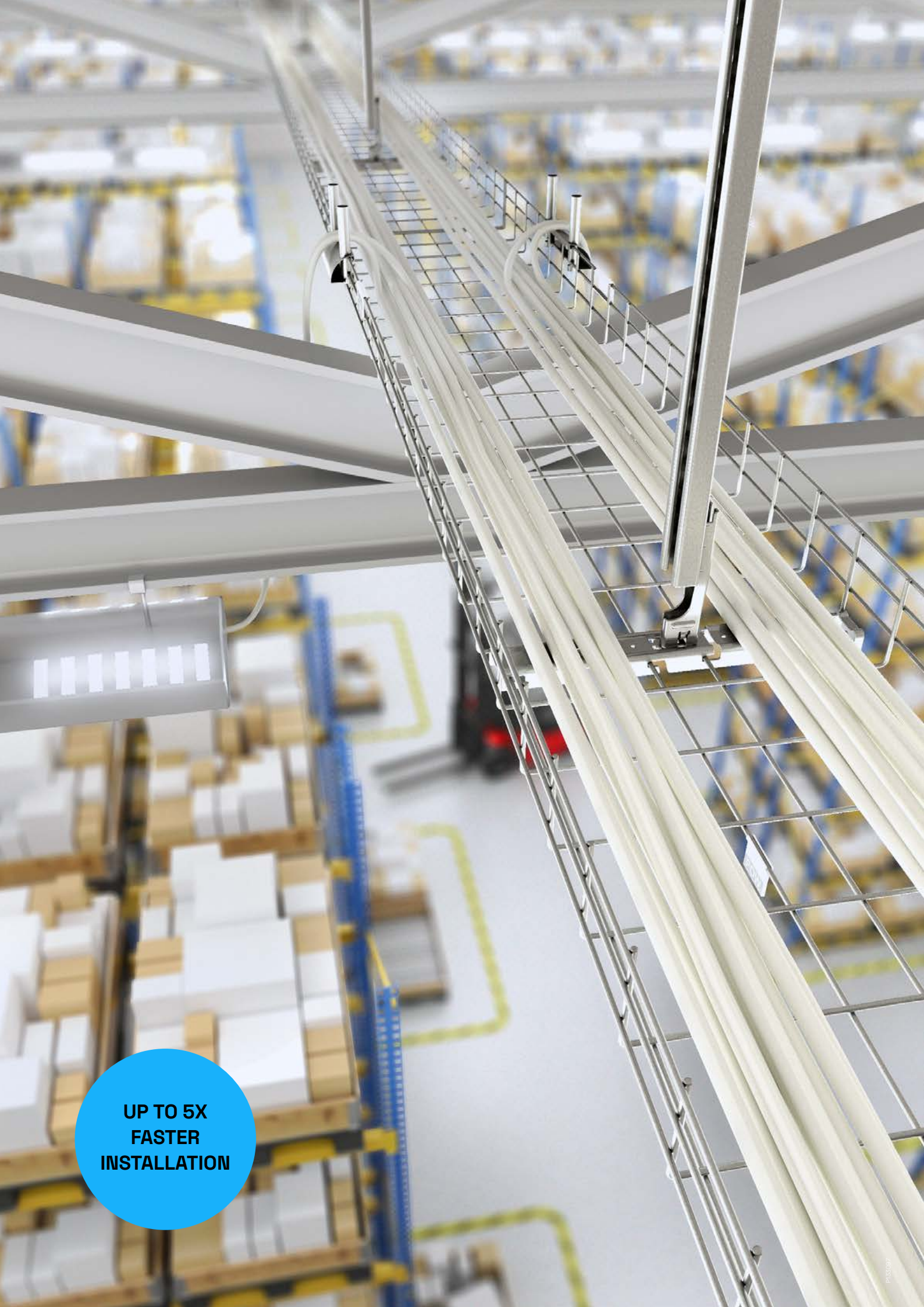

**UP TO 5X
FASTER
INSTALLATION**

Wibe CLX³ Smart. Lean. Simple.

CLX³ is developed to set new standards for the most efficient commercial building installations.

What makes CLX³ such a game changer?

- It's an innovative system optimized for commercial buildings and offices.
- It's built to be highly efficient to save time, costs and resources.
- It's developed to be modular and multi-functional.
- It is light and at the same time very robust.

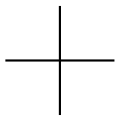

Flexible: The pendant accommodates installations close to the wall, corners and any other space.

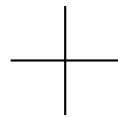

Single bolt ceiling plate: Fixes the pendant to the construction ceiling for optimal installation speed.

Time saving

Unique click system takes away the need for fixation clamps, bolts and nuts.

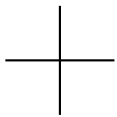
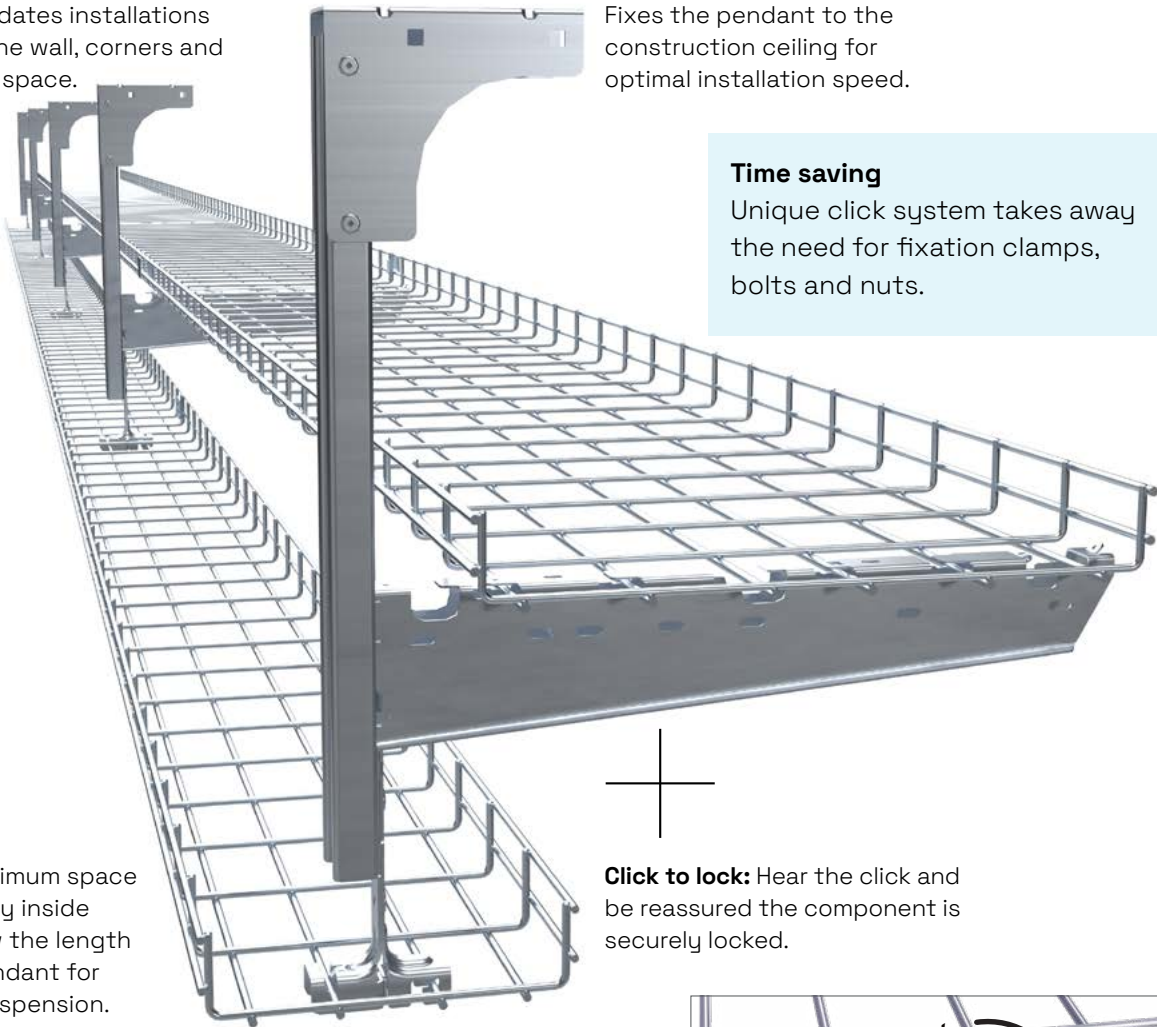

Sleek: Minimum space occupancy inside and below the length of the pendant for central suspension.

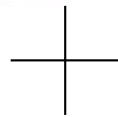

Click to lock: Hear the click and be reassured the component is securely locked.



Secure locking feature prevents unclicking.

Defem mesh trays comply to E30, E60 and E90 fire protection

The longer the mesh trays are resistant to fire, the longer the electric system will be able to operate normally. Defem products with E30 and E90 certification will help to protect life and property in the event of a fire. The well-proven, reliable system will prolong the access to critical emergency services, such as fire suppression systems, emergency lighting, ventilation and other basic installations.

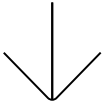

The Defem mesh trays meet the toughest product standards: IEC 61537 DIN 4102-12 for fire resistance E30, E60 and E90

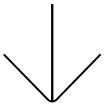

Defem is the only mesh tray approved by Det Norske Veritas (DNV) for offshore and ship-yard use.



About the test

A large amount of the Defem products have excellent fire resistance properties. You can feel confident when installing Defem in environments requiring both, E60 and E90 certification.

The Defem products exceeded the fire resistance test, qualifying for the highest level of resistance proposed by this standard – the E90. The trays with accessories and Dätwyler Pyrofil KERAM E30, E60 and E90 cables were tested for 90 minutes in a temperature of up to 1000°C without collapsing, with the electrical performance still remaining intact.

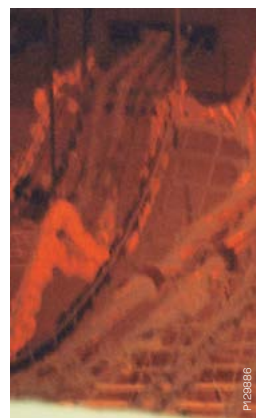

During the test

Defem system with Dätwyler Pyrofil KERAM E30, E60 and E90 cables during the test.



After the test

Defem system after 90 minutes of fire test. The electrical performance is still intact.

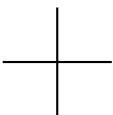

Stands 90 minutes in a temperature of up to 1000°C.

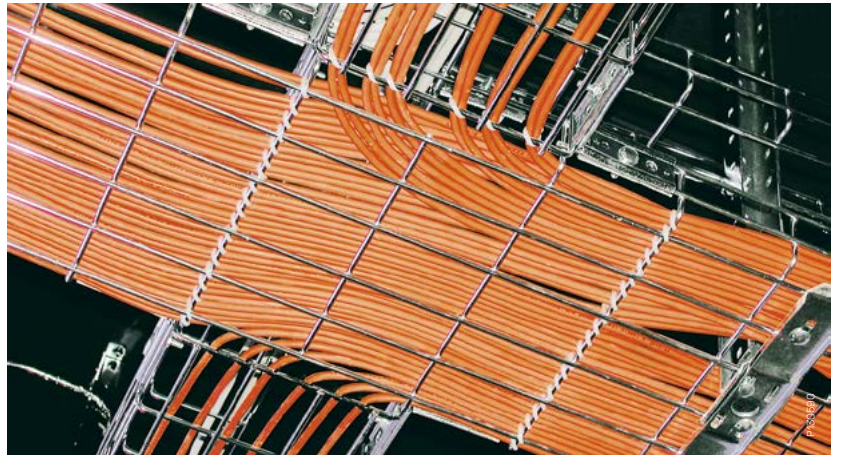
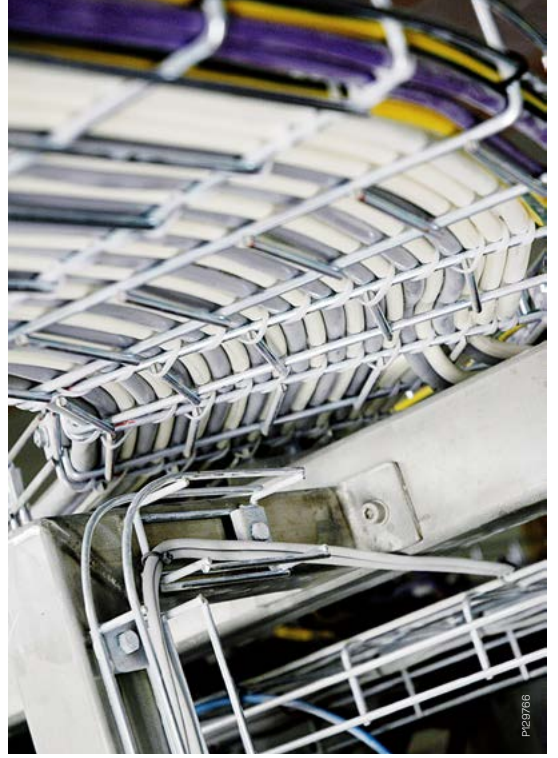
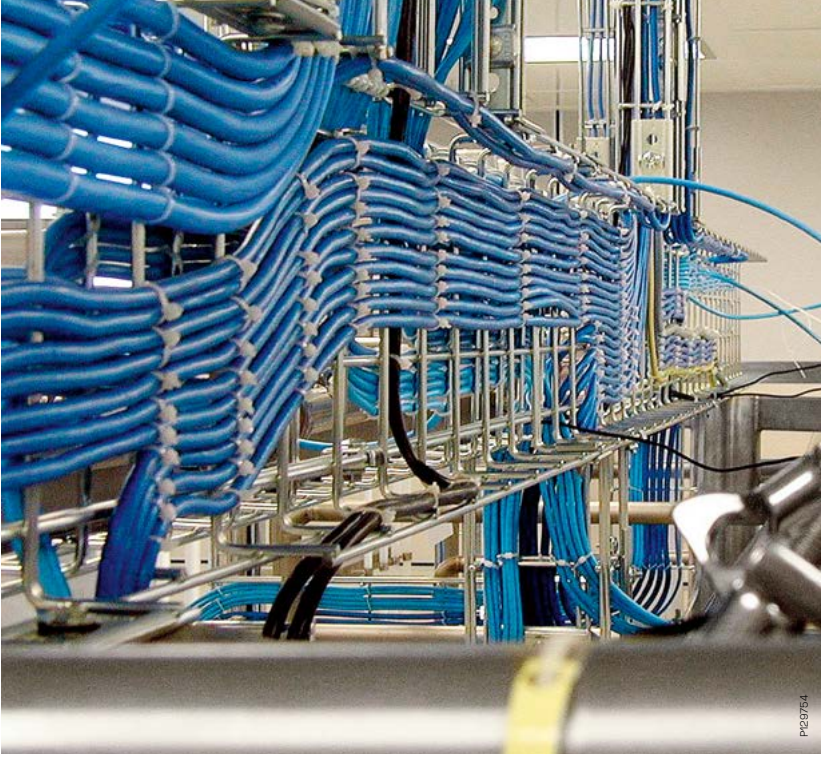

Installation summary

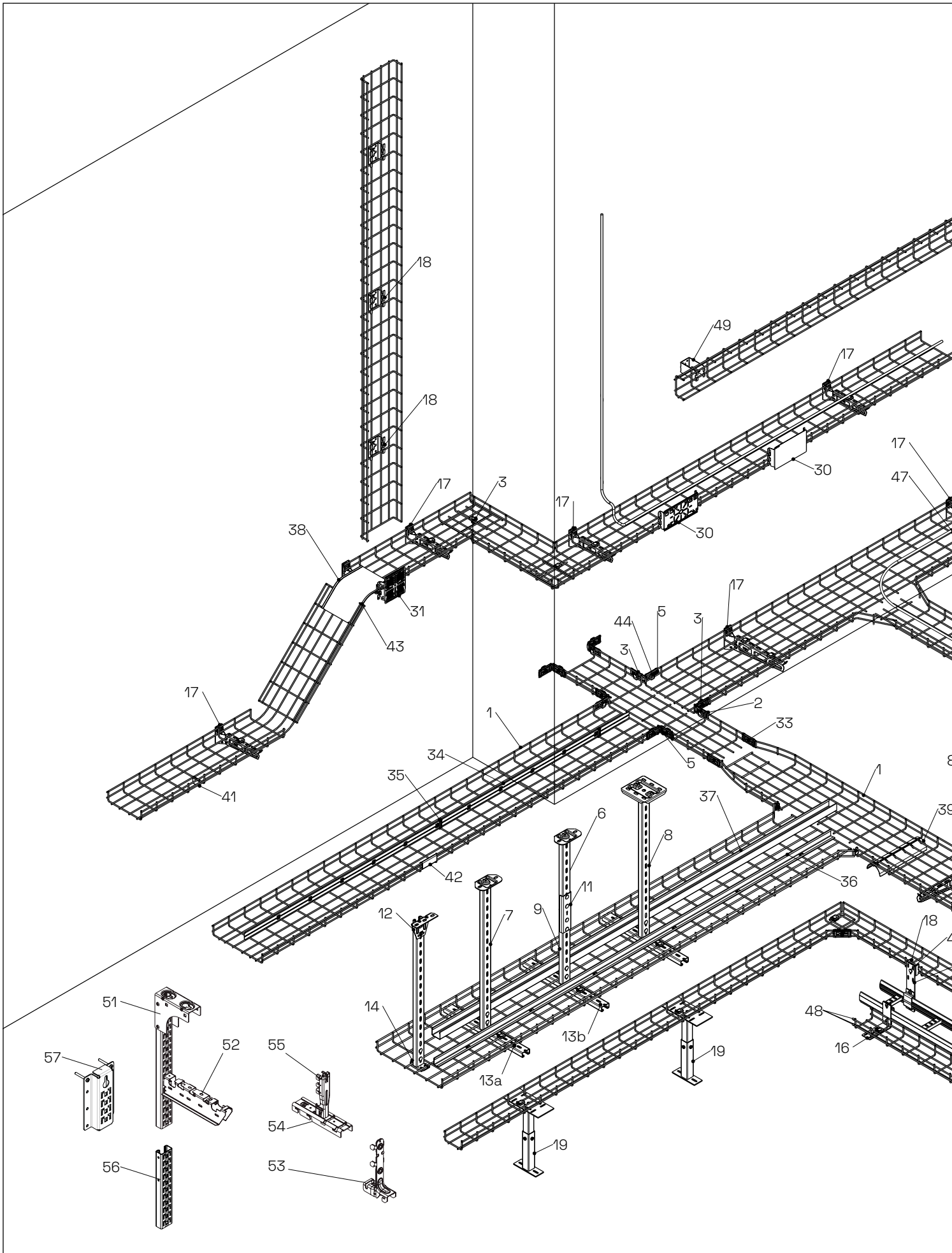

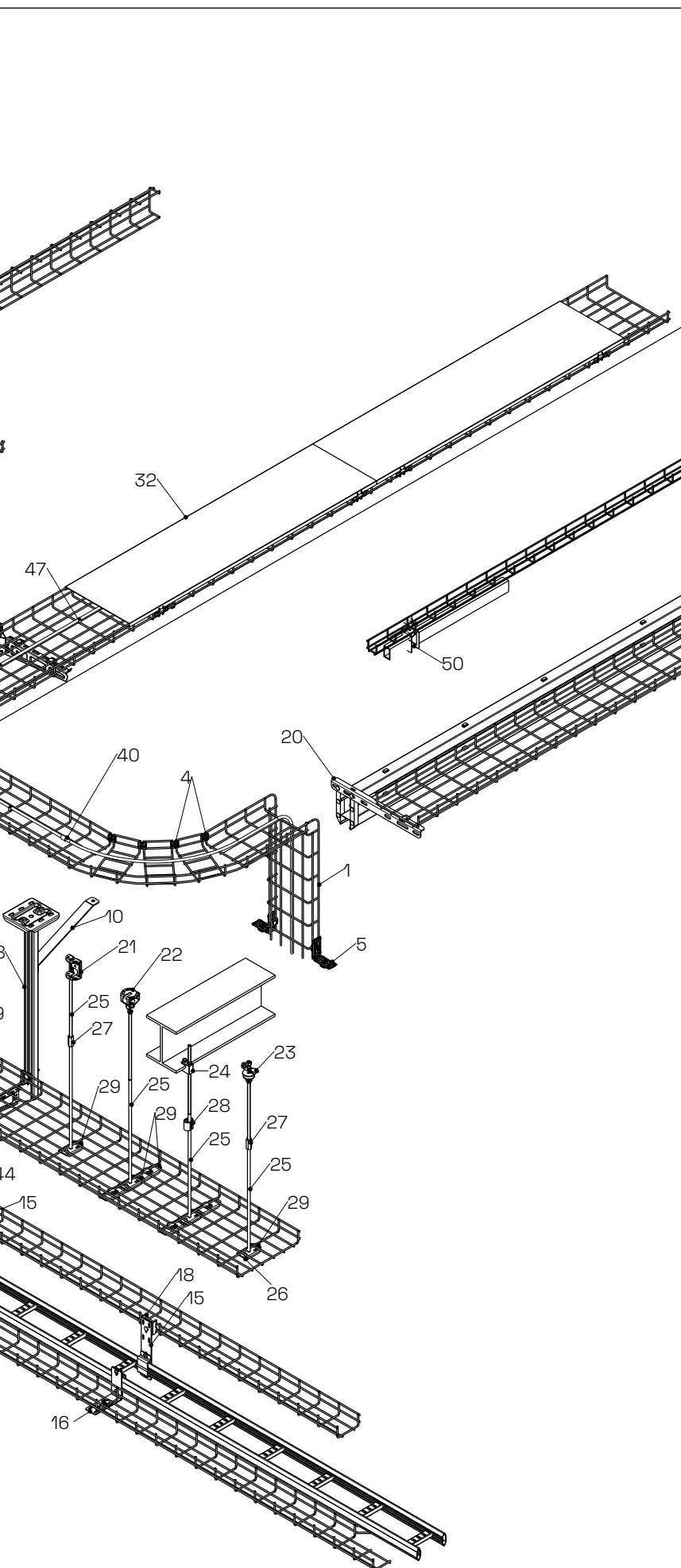

- 1** Mesh trays
Mesh trays C,G,Z
Mini Mesh B30-D,-U,-I
- 2** Fitting B1
- 3** Fitting B2
- 4** Fitting B3
- 5** Angled Fitting B27
- 6** Vertical piece 2
- 7** Vertical piece 2F
- 8** Vertical piece 2FB
- 9** Pendant/fixing rail 24/48
- 10** Pendant bar 1
- 11** Pendant joint 2FJ
- 12** Ceiling bracket 5
- 13a** Support Hook D35/320-422
- 13b** Support Hook D35/422-622
- 14** Support Hook D35/120-220
- 15** Combi Fitting B21
- 16** Combi Fitting B21 90°
- 17** Cantilever arm 50i
- 18** Bracket B4, B4 mini
- 19** Support B33
- 20** Conveyor Bracket B17
- 21** Ceiling Fitting Universal B46
- 22** Ceiling Fitting Flexible B47
- 23** Ceiling Clamp B48
- 24** Beam Clamp B49
- 25** Threaded Rod B41
- 26** Flange Nut B43
- 27** Distance Nut B42
- 28** Thread Lock B50
- 29** Support Hook B39
- 30** Accessories Holder B5 with or without holes
- 31** Accessories Holder B5 mini
- 32** Plate Cover B7 + Spring clip B8
- 33** Joining set B52
- 34** Separating Plate B36
- 35** Plate Holder B38
- 36** Separating Plate B26
- 37** Tele-Channel B6
- 38** Bend Plate B31
- 39** Radius Limiter B11, B34, B67
- 40** Velcro B51
- 41** Identification Tag B40
- 42** Marking Clip B44
- 43** Earth Connection Clamp B18
- 44** Bolt and Nut B13
- 48** Safety Cap B32
- 49** Bracket B4 100
- 50** Fixing for Canalis KBA and KBB
- 51** CLX³ Pendant 24/48
- 52** CLX³ Cantilever arm
- 53** CLX³ Central suspension bracket,
Defem mesh tray 120-220
- 54** CLX³ Central suspension bracket,
Defem mesh tray 320 to 422
- 55** CLX³ Central suspension adapter
- 56** CLX³ Rail 24/48
- 57** CLX³ Wall bracket

Steel mesh trays

Electro-galvanized/Pre-galvanized - Corrosion class C1

Mesh trays, electro-galvanized

Type	Dimensions A/B/C mm		Weight kg/100 pcs	EAN code	Ref. No.
------	---------------------	---	-------------------	----------	----------

Mesh trays, 45, 55 and 60 mm high

P140889



Mesh cable tray, length 2.5 m. Size 75/55 available both made of ϕ 4 and 5 mm wire, see dimension table below.
Material: Steel, electro-galvanized.

53/45	45/53/2500		175	7332227011136	1149113
75x4/55	55/75/2500		187	7332227011006	1149100
75x5/55	55/75/2500		290	7332227011105	1149110
120/60	60/120/2500		311	7332227011013	1149101
220/60	60/220/2500		430	7332227011020	1149102
320/60	60/320/2500		546	7332227011037	1149103
422/60	60/422/2500		757	7332227011143	1149114
522/60	60/522/2500		895	7321677886852	1149115
622/60	60/622/2500		1040	7321677886869	1149116

Mesh trays, 110 mm high

P140885

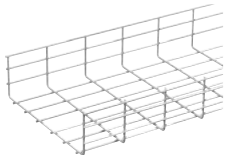

Mesh cable tray, length 2.5 m.
Material: Steel, electro-galvanized.

120/110	110/120/2500		430	7332227011044	1149104
220/110	110/220/2500		546	7332227011051	1149105
320/110	110/320/2500		663	7332227011068	1149106
422/110	110/422/2500		895	7332227011075	1149107
522/110	110/522/2500		1044	7332227011082	1149108
622/110	110/622/2500		1083	7332227011099	1149109

Dimension table

B221639

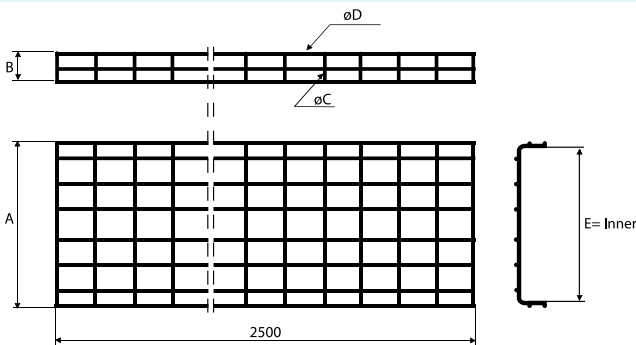

B221640

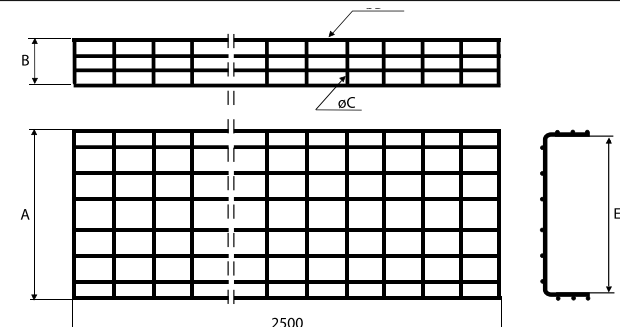

Type	A mm	B mm	C mm	D mm	E mm	Ref. No.
Mesh tray 53/45	53	45	4	4	37	1149113
Mesh tray 75x4/55	75	55	4	4	59	1149100
Mesh tray 75x5/55	75	55	5	5	55	1149110
Mesh tray 120/60	120	60	5	5	100	1149101
Mesh tray 220/60	220	60	5	5	200	1149102
Mesh tray 320/60	320	60	5	5	300	1149103
Mesh tray 422/60	422	60	5	6	400	1149114
Mesh tray 522/60	522	60	5	6	500	1149115
Mesh tray 622/60	622	60	5	6	600	1149116
Mesh tray 120/110	120	110	5	5	100	1149104
Mesh tray 220/110	220	110	5	5	200	1149105
Mesh tray 320/110	320	110	5	5	300	1149106
Mesh tray 422/110	422	110	5	6	400	1149107
Mesh tray 522/110	522	110	5	6	500	1149108
Mesh tray 622/110	622	110	5	6	600	1149109



Steel mesh trays

Electro-galvanized/Pre-galvanized - Corrosion class C1

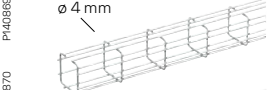
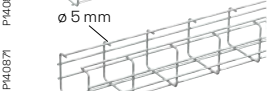
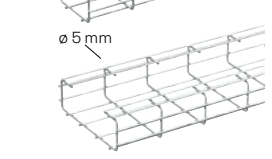
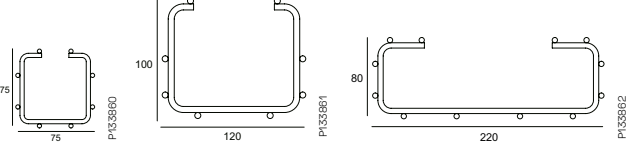
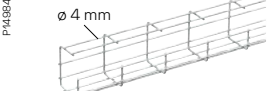
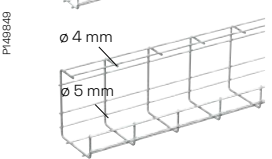
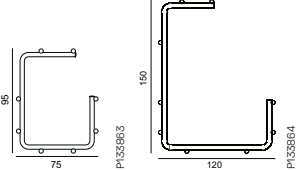
C and G-Mesh trays

Type	Dimensions A/B/C mm		Weight kg/100 pcs	EAN code	Ref. No.
C-mesh trays					
C-shaped mesh cable tray, length 2.5 m, for use where mounting with long support distances (up to 4 metres) are needed. Material: Steel, electro-galvanized.					
 P140866	75x75	75/75/2500	258	7332227011327	1149132
 P140870	120x100	100/120/2500	437	7332227011334	1149133
 P140871	220x80	80/220/2500	634	7332227011341	1149134
					
G-mesh trays					
G-shaped mesh cable tray, length 2.5 m, for installation in ceilings, onto walls, under desks and for mounting on cable ladders. Material: Steel, electro-galvanized.					
 P148848	75x95	95/75/2500	256	7332227011389	1149138
 P148849	120x150	150/120/2500	356	7332227011396	1149139
					

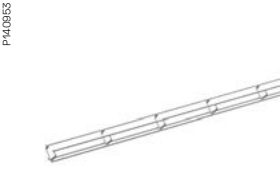

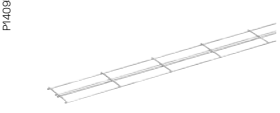





Mini Mesh trays

Mini mesh trays B30-D					
Mini mesh tray for the routing of cables. Diamond-shaped for good guiding and protection. Mesh tray length 2 m, wire \varnothing 3 mm. Material: Steel, electro-galvanized.					
 P140853	B30-D	24/30/2000	50	7332227011129	1149112
Mini mesh trays B30-U					
Mini mesh tray in a space-saving U-shape for the routing of cables. Mesh tray length 2 m, wire \varnothing 3 mm. Material: Steel, electro-galvanized.					
 P140854	B30-U	15/46/2000	50	7332227011259	1149125
Mini mesh trays B30-I					
Mini mesh tray in a space-saving plane design for the routing of cables. Mesh tray length 2 m, wire \varnothing 3 mm. Material: Steel, electro-galvanized.					
 P140855	B30-I	6/60/2000	50	7332227011112	1149111



Steel mesh trays

Electro-galvanized/Pre-galvanized - Corrosion class C1



Fittings

Type	Dimensions A/B/C mm 	Weight kg/100 pcs	EAN code	Ref. No.
Fitting B1				
 P140966	Fitting to be used as a wall bracket. It can also be mounted over the centre wires as a carrier of lighting fittings. Can also be used in 90 degree angles or as a joining fitting. Delivered without bolt and nut. Material: Steel, electro-galvanized.			
B1	40/5/80	4.8	7332227011549	1149154
Fitting B2				
 P140967	Fitting to be used to join mesh trays. Can also be used in 90 degree angles. Delivered without bolt and nut. Material: Steel, electro-galvanized.			
B2	35/7/25	2	7332227011556	1149155
Fitting B3				
 P140968	Fitting to be used when jointing wires in horizontal and vertical bends, in four-way and tee-junctions, etc. Delivered with bolt and nut. Material: Steel, electro-galvanized.			
B3	20/29/23	4	7332227011563	1149156
Angled fitting B27				
 P140969	Angled fitting for creating T-junctions or for connections to wall, ceiling and floor. Also for bends with adjustable angle. Material: Steel, electro-galvanized.			
B27	85/40/85	13	7332227011693	1149169
Mounting coupler B20				
 P140983	Mounting coupler to be used for joining and mounting of mini mesh trays. Material: Steel, electro-galvanized.			
B20	9/19/85	2	7332227011310	1149131
Joining set B52				
 P140980	Pre-assembled joining fitting including Fittings B1 and B2, Bolt and Nut B13. Used to join the side sections of all mesh trays. Material: Steel, electro-galvanized.			
B52	41/25/80	8	7332227011532	1149153
Bolt and nut B13				
 P14021	Bolt and nut M6x25. Tensi-lock and flange nut M6. Material: Steel, electro-galvanized.			
B13, 50+50 pcs	30/18/18	0.56/bag	7332227011846	1149184
B13, 250+250 pcs	30/18/18	2.82/bag	7332227011853	1149185

Brackets

Bracket B4/B4 Mini				
 P140981	Bracket to be used for the mounting of mesh trays 53-622 onto wall and floor. Material: Steel, pre-galvanized.			
B4	85/30/95	14	7332227011570	1149157
 P140982	Bracket to be used for the mounting of mesh trays 53-622 onto wall and floor. Material: Steel, pre-galvanized.			
B4 Mini	53/23/55	6	7332227011983	1149198

Cantilever arms

Cantilever arm 50i				
 P138932	Cantilever arm to be used for mountings on walls, vertical pieces or pendant/fixing rails. Material: Steel, pre-galvanized.			
50i/100	80/150/43	19	7321677914128	791412
50i-200	85/250/43	29	7321677914135	791413
50i-300	110/350/43	46	7321677914142	791414
50i-400	115/450/44	83	7321677914159	791415
50i/500	150/580/50	160	3606480911354	CSU795322
50i/600	150/680/50	186	3606480911361	CSU795323
T-bolt 26U M8x30				
 T-bolt single	T-bolt to be used for the mounting of cantilever arm 50i on Pendant/fixingrail 24/48 and vertical piece 2F/2FB. Material: Steel, hot-dip-galvanized.			
T-bolt 26U M8x30	50/44/18	6.8	3606489579777	CSU795595

Steel mesh trays

Electro-galvanized/Pre-galvanized - Corrosion class C1

Vertical pieces

Type	Dimensions A/B/C mm		Weight kg/100 pcs	EAN code	Ref. No.
Vertical piece 2					
Vertical piece to be used for installation of support bracket 3, symmetrical loading. Not suitable for cable ladders KHZV and KHZPV. Can be joined to Pendant/fixing rail 24/34 with Pendant joint 2J. Material: Steel, electro galvanized.					
2-300	279/80/135		52	3606489475895	CSU795572
2-500	504/80/135		72	3606489475901	CSU795573
2-1000	1022/80/135		120	3606489475918	CSU795574
Vertical piece 2F					
Vertical piece to be used for installation of central suspension bracket D35 and cantilever arm 50i. Can be joined to Pendant/fixing rail 24/48 with Pendant joint 2FJ. Material: Steel, electro-galvanized.					
2F-280	280/135/80		80	3606480911422	CSU795329
2F-505	505/135/80		130	3606480911439	CSU795330
2F-1000	1000/135/80		220	3606480911446	CSU795331
Vertical piece 2FB					
Reinforced vertical piece to be used for installation of central suspension bracket D35 and cantilever arm 50i. Can be joined to Pendant/fixing rail 24/48 with Pendant joint 2FJ. Material: Steel, electro-galvanized.					
2FB-280	280/155/150		113	3606480911453	CSU795332
2FB-505	505/155/150		163	3606480911460	CSU795333
2FB-1000	1000/155/150		253	3606480911477	CSU795334
Pendant B12 for fire resistance installations E30 - E90					
Pendant for specific fire certified installations according to DIN 4102-12 Classification E30 - E90. Specifically to be used to suspend the Defem electro-galvanized mesh trays in combination with cantilever arm 50i. Telescopic extension with B19. Material: Steel, electro-galvanized.					
Pendant B12	500/142/142		188	3606480920462	CSU795354

Ceiling and joining fittings, support, pendant joints

Ceiling bracket 5					
Ceiling bracket to be used for installations with Pendant/Fixing rail 24/48. Screw set 22S included. Material: Steel, pre-galvanized.					
5	100/135/40		35	7321677211012	721101
Pendant/fixing rail 24/48					
Pendant/Fixing rail for mounting of support brackets, cantilever arms etc. Material: Steel, pre-galvanized.					
24/48	1000/26/48		175	3606481317858	CSU795564
24/48	2970/26/48		520	7321677317172	731717
Extension B19 for fire resistance installations E30 - E90					
Telescopic pendant extension for specific fire certified installations according to DIN 4102-12 Classification E30 - E90. Specifically to be used to extend pendant B12. Material: Steel, electro-galvanized.					
B19/1000	1000/61/21		172	3606480920479	CSU795355
Pendant joint 2FJ					
Pendant joint to be used for joining pendant/fixing rails and vertical pieces. Screws M8x16 and nuts included. Material: Steel, pre-galvanized.					
2FJ	200/18/55		46	3606480911385	CSU795325
Pendant bar 1					
Pendant bar to be installed in order to reduce the deflection of heavily loaded vertical pieces. Installed with T-bolt and Expansion bolt. Material: Steel, pre-galvanized.					
1-500	515/166/40		53	7321677927289	792728

Steel mesh trays

Electro-galvanized/Pre-galvanized - Corrosion class C1

Ceiling and joining fittings, support

Type	Dimensions A/B/C mm		Weight kg/100 pcs	EAN code	Ref. No.
Ceiling fitting, universal B46					
Universal ceiling fitting intended for mounting of Threaded rod B41 onto ceiling. Material: Steel, electro-galvanized.					
B46	75/30/60		9	7332227014748	1149474
Ceiling fitting, flexible B47					
Flexible ceiling fitting that adapts to the inclination of the ceiling. Delivered complete with Tensi-lock flange nut. Material: Steel, electro-galvanized.					
B47/M8	65/65/65		12	7332227014755	1149475
B47/M10	65/65/65		13	7332227014762	1149476
Ceiling clamp B48					
Ceiling clamp for hole dimension Ø 22 mm. Delivered complete with Tensi-lock nut and washers. Material: Steel, electro-galvanized.					
B48/M8	20/20/75		6	7332227014724	1149472
B48/M10	20/20/75		7	7332227014731	1149473
Screw set 22S					
Screw set to be used for installation of central suspension bracket D35 on Vertical piece 2F/2FB, central suspension bracket D35 and Ceiling bracket 5 on Pendant/fixing rails 24/48, and Pendant/fixing rails back to back. Set including screw MVBFB 8x16 and nut M6MF8. Material: Steel, hot-dip galvanized.					
22S	—		1.9	7321677136940	713694

Support hooks

Support hook D35/120-220					
Support hook intended for 120-220 mm mesh trays. Material: Steel, electro-galvanized.					
D35/120-220	145/48/94		19	3606480911576	CSU795344
Support hook D35/320-422					
Reinforced support hook intended for 320-422 mm mesh trays. Material: Steel, electro-galvanized.					
D35/320-422	161/48/310		37	7332227011204	1149120
Support hook D35/422-622					
Reinforced support hook intended for 422-622 mm mesh trays. Material: Steel, electro-galvanized.					
D35/522-622	161/48/490		91	3606480911590	CSU795346
Support hook B39					
Support hook for mounting onto a Threaded rod. For tray widths 120-220 and 320-422 respectively. Material: Steel, electro-galvanized.					
B39/120-220	25/50/95		8	7332227011174	1149117
B39/320-422	25/50/290		30	7332227011181	1149118





Threaded rods

Threaded rod B41					
Threaded rod according to metric standard 6G. Material: Steel, electro-galvanized.					
B41/M8	8/8/1000		31	7332227014519	1149451
	8/8/2000		63	7332227014526	1149452
B41/M10	10/10/1000		49	7332227014618	1149461
	10/10/2000		98	7332227014625	1149462



Steel mesh trays

Electro-galvanized/Pre-galvanized - Corrosion class C1

Nuts, locks, clamps













Type	Dimensions A/B/C mm		Weight kg/100 pcs	EAN code	Ref. No.
Flange nut B43					
Flange nut to be mounted onto Threaded rod B41 in order to lock it to the Support hook and the Ceiling fittings. Material: Steel, electro-galvanized.					
	B43/M8, 50 pcs	8/17/17	0.4/bag	7321677888474	1149405
	B43/M10, 50 pcs	15/20/20	0.56/bag	7332227014649	1149464
Distance nut B42					
Distance nut to be used when joining Threaded rods. Material: Steel, electro-galvanized.					
	B42/M8	30/15/15	1	7332227014557	1149455
	B42/M10	40/20/20	2	7332227014656	1149465
Thread lock B50					
Thread lock to be used when joining Threaded rods. Material: Zinc, electro-galvanized.					
	B50/M8	35/10/20	1	7332227014564	1149456
	B50/M10	35/12/24	2	7332227014663	1149466
Beam clamp B49					
Beam clamp intended for mounting onto a beam. Material: Steel, electro-galvanized.					
	B49	60/43/20	14	7332227014717	1149471

Accessory holders

Accessory holder B5 Mini					
Accessory holder with a universal hole pattern for the mounting of a variety of boxes and outlets. The holder is easy to mount in different directions and angles on a mesh tray. The holder is tightened to the mesh tray by closing the grip around the wires. Material: Steel, pre-galvanized.					
	B5 Mini	140/24/170	20	7332227011372	1149137
	Accessory holder B5				
Accessory holder without holes or with a universal hole pattern for the mounting of a variety of boxes and outlets. The holder is easy to mount in different directions and angles on a mesh tray. The holder is tightened to the mesh tray by closing the grip around the wires. Material: Steel, electro-galvanized.					
	B5 with holes	107/24/240	43	7332227011587	1149158
		B5 without holes	107/24/240	46	7332227011686

Steel mesh trays

Electro-galvanized/Pre-galvanized - Corrosion class C1

Accessories					
Type	Dimensions A/B/C mm		Weight kg/100 pcs	EAN code	Ref. No.
Plate cover B7					
Mesh tray plate cover, for tray widths acc. to the type designation. Note! Requires B8 spring cover clip to fix the cover on the mesh tray. It must be ordered separately. Cover length 1250 mm. Material: Steel, Zinc+.					
	B7/75	16/80/1250	70	7321677958788	CSU795878
	B7/120	16/125/1250	110	7321677958795	CSU795879
	B7/220	16/226/1250	175	7321677958801	CSU795880
	B7/320	16/326/1250	240	7321677958818	CSU795881
	B7/422	16/426/1250	310	7321677958825	CSU795882
Spring cover clip B8					
Spring wire clip for fixing of B7 covers to the DEFEM mesh trays. Allows easy clicking and unclicking. Minimum 4 clips per cover is recommended. Note! Horizontal installation only. For vertical installation consult Wibe Group for advice. Packed in bag of 20 pcs. Material: Stainless 316L					
	B8	44/10/23	0.2	3606481920324	CSU795790
Separating plate B36 and Plate holder B38					
Separating plate for simple joining by entering plates into each other. Plate holder B38 is used to mount the separating plates onto a mesh tray. Material: Zinc, pre-galvanized.					
	B36	38/4/2400	65	7332227012768	1149276
Plate holder to be used for mounting of Separating plate B36, 5 pcs/Separating Plate. Material: Zinc, electro-galvanized.					
	B38	50/15/20	3	7332227012898	1149289
Separating plate B26					
L-shaped separating plate, fixed to the mesh tray by bending the flaps around the transversal wires. Material: Steel, pre-galvanized.					
	B26, L-shaped	40/30/2500	114	7332227012782	1149278
Tele-channel B6					
Tele-channel to be fixed to the mesh tray by bending the flaps around the transversal wires. Material: Steel, pre-galvanized.					
	B6	40/50/2500	195	7332227012478	1149247
Combi-fittings B21					
Combi-fitting to be mounted onto cable ladders. Material: Steel, electro-galvanized.					
	B21	250/50/20	44	7332227011594	1149159
	B21 90 degrees	120/50/135	44	7332227011914	1149191
Support B33					
Support to be used for mounting of all mesh trays on the floor, for example under a raised floor. The height of B33 Support is adjustable from 215 to 370 mm. The upper or lower part can be adjusted in a 90° angle. Material: Steel, electro-galvanized.					
	B33	215/100/220	169	7332227011358	1149135
Conveyor bracket B17					
Universal fitting to be used when mounting mesh trays along conveyor systems. Material: Steel, electro-galvanized.					
	B17	35/450/35	52	7332227011921	1149192
Fixing for Canalis KBA and KBB					
Fixing bracket to fix Canalis busbar trunking to the mesh trays. Hole for M6 on top, dia. 6.5 mm. Maximum load 60 kg. Material: Steel, pre-galvanized.					
	For Canalis KBA	78/38/52.5	65	3606480461590	CSU794592
	For Canalis KBB	78/38/68.5	78	3606480461606	CSU794593
Earth connection clamp B18					
Earth connection clamp to be used to mount earth cable onto a chosen wire of the mesh tray. Material: Brass, electrolytically nickel coated.					
	B18	15/30/15	2	321677887163	1149180

Steel mesh trays

Electro-galvanized/Pre-galvanized - Corrosion class C1

Accessories

Type	Dimensions A/B/C mm 	Weight kg/100 pcs	EAN code	Ref. No.
------	--	----------------------	----------	----------

End plug 28E

End plug to be mounted on Pendant 2F/2FB and on Pendant/fixing rail 24/48 respectively, see below. Intended to provide protection against personal injuries and to make the the ends of the profiles more conspicuous.
Material: PP/TPE, orange.

P410089



28E for Vertical piece 2F, pendant fixing rail 24/48 and CLX ³ pendant fixing rail 24/48.	24/30/52	0.5	7321677090211	709021
--	----------	-----	---------------	---------------

Safety cap B32

Safety cap of halogen-free and flame-proof plastic material. To be mounted onto wires sticking out. Bag with 100 pcs.
Material: PE.

P41001



B32/3	5/8/5	5	7332227013895	1149389
B32/4	8/10/8	5	7332227013888	1149388
B32/5	8/10/8	4	7332227013666	1149366
B32/6	8/10/9	3	7332227013673	1149367

Mounting spacer B22

Plastic spacer that fits all mini mesh-tray dimensions. Mounted by snapping the spacer onto the bottom wires. For 3 mm wire diameter. Bag with 10 pcs.
Material: PE.

P41002



B22	6/18/18	1.4	7332227015233	1149523
-----	---------	-----	---------------	----------------

Bend plate B31

Bend plate for smooth bending of cables when changing level. For tray widths 120, 220, 320 and 422 mm respectively.
Material: Aluminium.

P41005



B31/120	5/290/90	4	7332227012263	1149226
B31/220	5/290/190	9	7332227012270	1149227
B31/320	5/290/290	13	7332227012287	1149228
B31/422	5/290/390	17	7332227012294	1149229

Side radius limiter B11

Radius limiter to be used for limiting the side bend radius of any cable type. R = 40 mm.
Material: Steel, pre-galvanized.

P41004



B11/5 for mesh trays 75x5-320 mm	120/40/215	24	7332227014380	1149438
B11/6 for mesh trays 422-622 mm	120/40/215	24	7332227014397	1149439

Radius limiter B34

Radius limiter that limits the bend radius for sensitive cables. The radius limiter is mounted from below by using the locking stick.
Material: Steel, pre-galvanized.

B224734_1



B34/75	40/80/75	8	7332227014373	1149437
B34/120	40/80/115	10	7332227014311	1149431
B34/220	40/80/215	21	7332227014328	1149432
B34/320	40/80/315	32	7332227014335	1149433
B34/422	40/80/415	43	7332227014342	1149434
B34/522	40/80/515	55	7332227014359	1149435
B34/622	40/80/615	65	7332227014366	1149436

Steel mesh trays

Electro-galvanized/Pre-galvanized - Corrosion class C1

Accessories

Type	Dimensions A/B/C mm		Weight kg/100 pcs	EAN code	Ref. No.
Radius limiter B67					
Radius limiter that limits the bend radius and gives protection at side position. The radius limiter is mounted from below by using the locking stick. Material: Steel, pre-galvanized.					
B67/75	40/150/75		13	7332227014427	1149442
B67/120	40/150/115		18	7332227014434	1149443
B67/220	40/150/215		30	7332227014441	1149444
B67/320	40/150/315		42	7332227014458	1149445
B67/422	40/150/415		53	7332227014465	1149446
B67/522	40/150/515		65	7332227014472	1149447
B67/622	40/150/615		77	7332227014489	1149448
Velcro B51					
Velcro tape intended to attach bundles of cables onto a mesh tray. Length 22.8 m, colour black.					
B51/10	10/22.8		16	7332227186506	1518650
B51/20	20/22.8		32	7332227186513	1518651
Marking clip B44					
Plastic marking clip, flame-resistant, to be snapped onto the two side wires of the mesh tray. The Equipotential Bonding clip is available in Swedish, English and German. Package of 10 pcs. Material: ABS.					
B44	40/10/90		1	7332227014274	1149427
B44/Potentialutjämning, SE	40/10/90		1	7321677888566	1149428
B44/Equipotential Bonding, GB	40/10/90		1	7321677888573	1149429
B44/Potentialausgleich, DE	40/10/90		1	7321677888580	1149430
Identification tag B40					
Identification tag to be snapped onto mesh tray wires of Ø 5 mm. Package of 10 pcs. Material: ABS.					
B40/Opto	35/8/43		1	7332227014205	1149420
B40/Coax	35/8/43		1	7332227014212	1149421
B40/Pair	35/8/43		1	7332227014229	1149422
B40/Neutral	35/8/43		1	7332227014236	1149423
B40/Pow	35/8/43		1	7332227014243	1149424

P141006
P141005

P149448



P183791



P141014



P133792



P144015



P141016



P141017



P141018



P141019







P141020



Steel mesh trays

Electro-galvanized/Pre-galvanized - Corrosion class C1

Tools					
Type	Dimensions A/B/C mm		Weight kg/100 pcs	EAN code	Ref. No.
Cable roller B25					
	Cable roller intended to facilitate the pulling of cables into the mesh trays. Mounted on the mesh tray by pulling the black knob outwards. When the cable pulled by the cable roller has reached the desired distance, it is moved to the tray by pushing the small metal button to open the cable roller and removing it. Material: Stainless steel AISI316L, plastic.				
	B25	210/130/40	35	7332227019552	1653955
Bolt cutter B28					
	Bolt cutter with angled clipper cut head for narrow and clean cuts of mesh tray wires.				
	B28	140/40/630	272	7332227239981	1623998
Spanner B45					
	10 mm combination spanner, open end/flex head end. Material: Chrome vanadium steel.				
	B45	15/15/180	7	7332227222006	1622200

Steel mesh trays

CLX³ Click suspension - Corrosion class C2

Vertical piece/Fixing rail

Type	Dimensions A/B/C mm		Weight kg/100 pcs	EAN code	Ref. No.
CLX³ pendant 24/48					
Vertical piece/pendant to be used for ceiling suspended mounting. Perforated pattern to be used with CLX ³ cantilever arm or CLX ³ central suspension adapter. Open side can be used with T-bolt. Material: Steel, pre-galvanized.					
CLX ³ pendant-300	295/145/53		90.6	3606489904937	CSU795632
CLX ³ pendant-400	395/145/53		107.5	3606489904944	CSU795633
CLX ³ pendant-500	495/145/53		124.4	3606489904951	CSU795634
CLX ³ pendant-700	695/145/53		158.1	3606489904968	CSU795635
CLX ³ pendant-1000	995/145/53		208.7	3606489904975	CSU795636
CLX ³ pendant-1500	1495/145/53		294.2	3606481828323	CSU795638
CLX³ pendant rail 24/48					
Pendant rail to be used for direct wall mounting or for vertical piece/pendants extensions. To be connected to the vertical piece/pendant together with the pendant joint CSU795325. Perforated pattern to be used with CLX ³ cantilever arm. Open side can be used with T-bolt. Material: Steel, pre-galvanized.					
CLX ³ rail 24/48 300	280/48/26		47.2	3606481828330	CSU795640
CLX ³ rail 24/48 1000	980/48/26		165.1	3606481828347	CSU795641
CLX ³ rail 24/48 3000	2980/48/26		502	3606489904982	CSU795637

Adjustable ceiling plate

Type	Dimensions A/B/C mm	Weight kg/100 pcs	EAN code	Ref. No.
CLX³ adjustable ceiling plate				
Adjustable ceiling plate. To be used for angular adjustment of pendant vs ceiling. Adjustment between 0-25°. Adjustable ceiling plate is to be mounted to the CLX ³ pendant. To be assembled with 4 screw set 22S (713694), need to be ordered separately. Tightening force of the screw set minimum torque 20 N.m. Material: Steel, pre-galvanized.				
CLX ³ adjustable ceiling plate	150/100/59	49.8	3606489904999	CSU795639

Cantilever arms

Type	Dimensions A/B/C mm	Weight kg/100 pcs	EAN code	Ref. No.
CLX³ Cantilever arm				
Cantilever arm to be used for mounting on vertical pieces or pendant/fixing rails. The cantilever arm is designed for fast click fixation of ladder type KHZSP, Defem mesh tray height 60/110 and Stago tray KG281/KB184/KB284 height 60. Stago trays need to be fastened with the fast fixing clamp (CSU08490100). Material: Steel, pre-galvanized.				
CLX ³ cantilever arm 150	62/220/49	36.1	3606489905002	CSU795646
CLX ³ cantilever arm 200	62/280/49	42.8	3606489905026	CSU795647
CLX ³ cantilever arm 300	62/380/49	60.5	3606489905033	CSU795648
CLX ³ cantilever arm 400	92/480/49	90.9	3606489905040	CSU795649
CLX ³ cantilever arm 500	92/580/49	106.6	3606489905057	CSU795650
CLX ³ cantilever arm 600	92/680/49	119.7	3606489905064	CSU795651

Central suspensions

Type	Dimensions A/B/C mm		Weight kg/100 pcs	EAN code	Ref. No.
CLX³ central suspension bracket, mesh tray Defem					
Central suspension bracket be used for mounting Defem mesh trays on vertical pieces. Material: Steel, pre-galvanized.					
120-220	163/31/84		19.5	3606489905200	CSU795665
320 *	25/206/50		31.3	3606489905217	CSU795666
422 *	25/397/50		62.7	3606489905231	CSU795668
522-622 *	25/497/50		78.2	3606489905224	CSU795667
(*) the central suspension bracket shall first be assembled together with the CLX ³ central suspension adapter (CSU795700) to be able to click in the perforation pattern on the vertical piece.					
CLX³ central suspension adapter					
Central suspension adapter to be first clicked to a CLX ³ central suspension bracket of choice. The adaptor fits to all types of CLX ³ central suspension brackets; ladder, tray and mesh. In a second step the adaptor with the central suspension bracket mounted is clicked in the perforation pattern in the rail or the pendant. Material: Steel, pre-galvanized.					
CLX ³ CSB adapter	166/31/39		17.7	3606489905248	CSU795700

Wall bracket

Type	Dimensions A/B/C mm	Weight kg/100 pcs	EAN code	Ref. No.
Wall bracket for CLX³ cantilevers.				
To be used for direct fixation to wall. Single bolt fixation in keyhole, alternatively multi-bolt fixation in lateral holes for softer walls. Bolts are not included. Material: Steel, pre-galvanized.				
Wall bracket for CLX ³ cantilevers	163/101/26	34	7321677958047	CSU795804

Steel mesh trays

Hot-dip galvanized - Corrosion class C2-C4

Mesh trays, HDG

Type	Dimensions A/B/C mm		Weight kg/100 pcs	EAN code	Ref. No.
------	---------------------	--	-------------------	----------	----------

Mesh trays, 45, 55 and 60 mm high

Mesh cable tray, length 2.5 m. Size 75/55 available both made of ø 4 and 5 mm wire, see dimension table below.
Material: Steel, HDG.

P140858



53/45	45/53/2500		185	7332227012133	1149213
75x4/55	55/75/2500		204	7332227012003	1149200
75x5/55	55/75/2500		306	7332227012102	1149210
120/60	60/120/2500		340	7332227012010	1149201
220/60	60/220/2500		453	7332227012027	1149202
320/60	60/320/2500		585	7332227012034	1149203
422/60	60/422/2500		817	7332227012140	1149214
522/60	60/522/2500		949	7321677887354	1149215
622/60	60/622/2500		1106	7321677887361	1149216

Mesh trays, 110 mm high

Mesh cable tray, length 2.5 m.
Material: Steel, HDG.

P140865

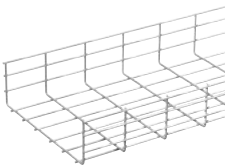

120/110	110/120/2500		453	7332227012041	1149204
220/110	110/220/2500		584	7332227012058	1149205
320/110	110/320/2500		709	7332227012065	1149206
422/110	110/422/2500		949	7332227012072	1149207
522/110	110/522/2500		1106	7321677887309	1149208
622/110	110/622/2500		1148	7321677887316	1149209

Dimension table

B225239

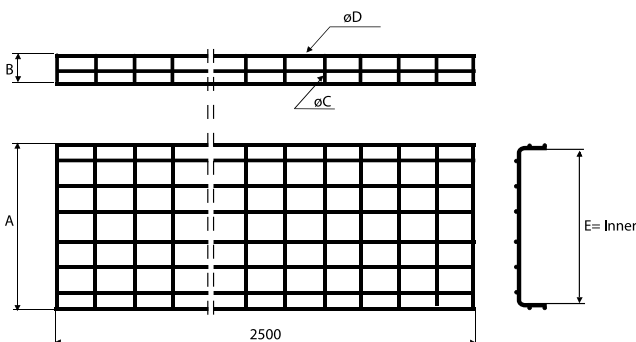



B225240

Type	A mm	B mm	C mm	D mm	E mm	Ref. No.
Mesh tray 53/45	53	45	4	4	37	1149213
Mesh tray 75x4/55	75	55	4	4	59	1149200
Mesh tray 75x5/55	75	55	5	5	55	1149210
Mesh tray 120/60	120	60	5	5	100	1149201
Mesh tray 220/60	220	60	5	5	200	1149202
Mesh tray 320/60	320	60	5	5	300	1149203
Mesh tray 422/60	422	60	5	6	400	1149214
Mesh tray 522/60	522	60	5	6	500	1149215
Mesh tray 622/60	622	60	5	6	600	1149216
Mesh tray 120/110	120	110	5	5	100	1149204
Mesh tray 220/110	220	110	5	5	200	1149205
Mesh tray 320/110	320	110	5	5	300	1149206
Mesh tray 422/110	422	110	5	6	400	1149207
Mesh tray 522/110	522	110	5	6	500	1149208
Mesh tray 622/110	622	110	5	6	600	1149209



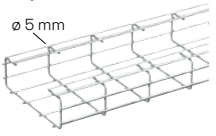
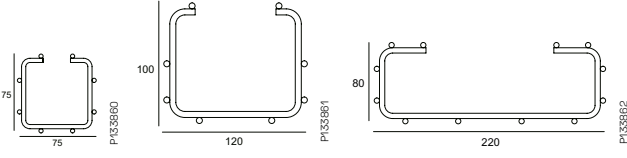
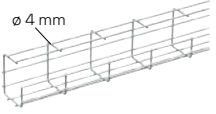
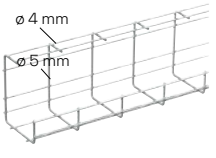
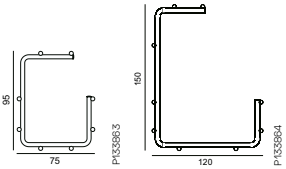

Steel mesh trays

Hot-dip galvanized - Corrosion class C2-C4

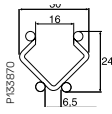

C and G-Mesh trays

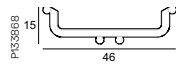
Type	Dimensions A/B/C mm		Weight kg/100 pcs	EAN code	Ref. No.
C-mesh trays					
C-shaped mesh cable tray, length 2.5 m, for use where mounting with long support distances (up to 4 metres) are needed. Material: Steel, HDG.					
  	75x75	75/75/2500	278	7332227012324	1149232
	120x100	100/120/2500	472	7332227012331	1149233
	220x80	80/220/2500	685	7332227012348	1149234
					
G-mesh trays					
G-shaped mesh cable tray, length 2.5 m, for installation in ceilings, onto walls, under desks and for mounting on cable ladders. Material: Steel, HDG.					
 	75x95	95/75/2500	278	7332227012386	1149238
	120x150	150/120/2500	472	7332227012393	1149239
					

Mini Mesh trays

Mini mesh trays B30-D					
Mini mesh tray for the routing of cables. Diamond-shaped for good guiding and protection. Mesh tray length 2 m, wire ϕ 3 mm. Material: Steel, HDG.					
	B30-D	24/30/2000	55	7332227012126	1149212
					
Mini mesh trays B30-U					
Mini mesh tray in a space-saving U-shape for the routing of cables. Mesh tray length 2 m, wire ϕ 3 mm. Material: Steel, HDG.					
	B30-U	15/46/2000	55	7332227012256	1149225
					
Mini mesh trays B30-I					
Mini mesh tray in a space-saving plane design for the routing of cables. Mesh tray length 2 m, wire ϕ 3 mm. Material: Steel, HDG.					
	B30-I	6/60/2000	55	7332227012119	1149211
					

Accessories

Plate cover B7					
Mesh tray plate cover, for tray widths acc. to the type designation. Cover length 1250 mm. Material: Zink+					
	B7/75	16/80/1250	70	7321677958788	CSU795878
	B7/120	16/125/1250	110	7321677958795	CSU795879
	B7/220	16/226/1250	175	7321677958801	CSU795880
	B7/320	16/326/1250	240	7321677958818	CSU795881
	B7/422	16/426/1250	310	7321677958825	CSU795882
Spring cover clip B8					
Spring wire clip for fixing of B7 covers to the DEFEM mesh trays. Allows easy clicking and unclicking. Minimum 4 clips per cover is recommended. Note! Horizontal installation only. For vertical installation consult Wibe Group for advice. Packed in bag of 20 pcs. Material: Stainless 316L					
	B8	44/10/23	0.2	3606481920324	CSU795790

Steel mesh trays

Hot-dip galvanized - Corrosion class C2-C4

Fittings					
Type	Dimensions A/B/C mm		Weight kg/100 pcs	EAN code	Ref. No.
Fitting B1					
Fitting to be used as a wall bracket. It can also be mounted over the centre wires as a carrier of lighting fittings. Can also be used in 90 degree angles or as a joining fitting. Delivered without bolt and nut. Material: Steel, HDG.					
B1	40/5/80		4.8	7332227012546	1149254
Fitting B2					
Fitting to be used to join mesh trays. Can also be used in 90 degree angles. Delivered without bolt and nut. Material: Steel, HDG.					
B2	35/7/25		2	7332227012553	1149255
Fitting B3					
Fitting to be used when jointing wires in horizontal and vertical bends, in four-way and tee-junctions, etc. Delivered with bolt and nut. Material: Steel, HDG.					
B3	20/29/23		4	7332227012560	1149256
Angled fitting B27					
Angled fitting for creating T-junctions or for connections to wall, ceiling and floor. Also for bends with adjustable angle. Material: Steel, HDG.					
B27	85/40/85		13	7332227012690	1149269
Mounting coupler B20					
Mounting coupler to be used for joining and mounting of mini mesh-wire trays. Material: Steel, HDG.					
B20	9/19/85		2	7332227012317	1149231
Joining set B52					
Pre-assembled joining fitting including Fittings B1 and B2, Bolt and Nut B13. Used to join the side sections of all mesh trays. Material: Steel, HDG.					
B52	41/25/80		8	7332227012539	1149253
Bolt and nut B13					
Bolt and nut M6x25. Tensi-lock and flange nut M6. Material: Steel HDG.					
B13, 50+50 pcs	30/18/18		0.57/bag	7332227012843	1149284
B13, 250+250 pcs	30/18/18		2.80/bag	7332227012850	1149285
Brackets					
Bracket B4/B4 Mini					
Bracket to be used for the mounting of mesh trays 53-622 onto wall and floor. Material: Steel, HDG.					
B4	85/30/95		15	7332227012577	1149257
B4 Mini	53/23/55		6	7332227012980	1149298
Cantilever arms					
Cantilever arm 50i					
Cantilever arm to be used for mountings on walls, vertical pieces or pendant/fixing rails. Material: Steel, HDG.					
50i/100	80/150/43		19	3606480911293	CSU795316
50i/200	85/250/43		29	3606480911309	CSU795317
50i/300	110/350/43		46	3606480911316	CSU795318
50i/400	115/450/44		83	3606480911323	CSU795319
50i/500	150/580/50		160	3606480911330	CSU795320
50i/600	150/680/50		186	3606480911347	CSU795321
T-bolt 26U M8x30					
T-bolt to be used for the mounting of cantilever arm 50i on Pendant/fixingrail 24/48 and vertical piece 2F/2FB. Material: Steel, hot-dip galvanized.					
T-bolt 26U M8x30	50/44/18		6.8	3606489579777	CSU795595

Steel mesh trays

Hot-dip galvanized - Corrosion class C2-C4

Vertical pieces

Type	Dimensions A/B/C mm		Weight kg/100 pcs	EAN code	Ref. No.
Vertical piece 2					
Vertical piece to be used for installation of support bracket 3, symmetrical loading. Not suitable for cable ladders KHZV and KHZPV. Can be joined to Pendant/fixing rail 24/34 with Pendant joint 2J. Material: Steel, hot-dip galvanized.					
2-300	279/80/135		52	7321677171910	717191
2-400	392/80/135		62	7321677171927	717192
2-500	504/80/135		72	7321677171934	717193
2-700	729/80/135		93	7321677171941	717194
2-1000	1022/80/135		120	7321677171958	717195
Vertical piece 2F					
Vertical piece to be used for installation of central suspension bracket D35 and Cantilever arm 50i. Can be joined to Pendant/fixing rail 24/48 with Pendant joint 2FJ. Material: Steel, hot-dip galvanized.					
2F-280	280/80/135		80	7321677171965	717196
2F-505	505/80/135		130	7321677171989	717198
2F-1000	1000/80/135		220	7321677172009	717200
Vertical piece 2FB					
Reinforced vertical piece to be used for installation of central suspension bracket D35 and Cantilever arm 50i. Can be joined to Pendant/fixing rail 24/48 with Pendant joint 2FJ. Material: Steel, hot-dip galvanized.					
2FB-280	280/155/150		113	3606480911484	CSU795335
2FB-505	505/155/150		163	3606480911491	CSU795336
2FB-1000	1000/155/150		253	3606480911507	CSU795337

Ceiling and joining fittings, support

Ceiling bracket 5					
Ceiling bracket to be used for installations with Pendant/Fixing rail 24/48. Screw set 22S included. Material: Steel, hot-dip galvanized.					
5	100/135/40		35	7321677186402	718640
Pendant/Fixing rail 24/48					
Pendant/Fixing rail for mounting of support brackets, cantilever arms, etc. Material: Steel, hot-dip galvanized.					
24/48	1000/26/48		175	3606481317865	CSU795565
24/48	2970/26/48		520	7321677050932	705093
Pendant joint 2FJ					
Pendant joint to be used for joining pendant/fixing rails and vertical pieces. Screws M8x16 and nuts included. Material: Steel, hot-dip galvanized.					
2FJ	200/55/18		46	7321677131785	713178
Pendant bar 1					
Pendant bar to be installed in order to reduce the deflection of heavily loaded vertical pieces. Installed with T-bolt and Expansion bolt. Material: Steel, hot-dip galvanized.					
1-500	568/-/40		53	7321677176410	717641
Screw set 22S					
Screw set to be used for installation of central suspension bracket D35 on Vertical piece 2F/2FB, central suspension bracket D35 and Ceiling bracket 5 on Pendant/fixing rails 24/48 and Pendant/fixing rails back to back. Set including screw MVBFB 8x16 and nut M6MFB. Material: Steel, hot-dip galvanized.					
22S	—		1.9	7321677136940	713694

Steel mesh trays

Hot-dip galvanized - Corrosion class C2-C4

Support hooks

Type	Dimensions A/B/C mm		Weight kg/100 pcs	EAN code	Ref. No.
Support hook D35/120-220					
Support hook intended for 120-220 mm mesh trays. Material: Steel, hot-dip galvanized.					
D35/120-220	148/48/94		19	3606480911606	CSU795347
Support hook D35/320-422					
Reinforced support hook intended for 320-422 mm mesh trays. Material: Steel, hot-dip galvanized.					
D35/320-422	161/48/310		37	7332227012201	1149220
Support hook D35/422-622					
Reinforced support hook intended for 422-622 mm mesh trays. Material: Steel, hot-dip galvanized.					
D35/422-622	161/48/490		91	3606480911620	CSU795349
Support hook B39					
Support hook for mounting onto a Threaded rod. For tray widths 120-220 and 320-422 respectively. Material: Steel, HDG.					
B39/120-220	25/50/95		8	7332227012171	1149217
B39/320-422	25/50/290		32	7332227012188	1149218

Threaded rods

Threaded rod W76					
Threaded rod for M8 ceiling mounting of cable support. For fixing, use Flange Nut M8 and for extension, Distance nut M8. Material: Steel, HDG.					
W76/M8	8/8/1000		32	3606480483783	CSU794697
	8/8/2000		64	3606480483776	CSU734698

Nuts

Flange nut					
Flange Nut M8 to be mounted on Threaded rod W76. Intended for ceiling mounting of cable support. Material: Steel, HDG.					
Flange nut M8	8/17/17		1	3606480483806	CSU794715
Distance nut					
Distance nut M8 to be used as an extension and a coupler of Threaded rod W76. Intended for ceiling mounting of cable support. Material: Steel, HDG.					
Distance nut M8	30/15/15		4	3606480483790	CSU794699

Accessory holders

Accessory holder B5 Mini					
Accessory holder with a universal hole pattern for the mounting of a variety of boxes and outlets. The holder is easy to mount in different directions and angles on a mesh tray. The holder is tightened to the mesh tray by closing the grip around the wires. Material: Steel, HDG.					
B5 Mini	140/24/170		21	7332227012379	1149237
Accessory holder B5					
Accessory holder without holes or with a universal hole pattern for the mounting of a variety of boxes and outlets. The holder is easy to mount in different directions and angles on a mesh tray. The holder is tightened to the mesh tray by closing the grip around the wires. Material: Steel, HDG.					
B5 with holes	107/24/240		43	7332227012584	1149258
B5 without holes	107/24/240		46	7332227012683	1149268

Steel mesh trays

Hot-dip galvanized - Corrosion class C2-C4

Accessories

Type	Dimensions A/B/C mm		Weight kg/100 pcs	EAN code	Ref. No.
Combi-fittings B21					
Combi-fitting to be mounted onto cable ladders. Material: Steel, HDG.					
B21	250/50/20		48	7332227012591	1149259
B21 90 degrees	120/50/135		46	7332227012911	1149291
Support B33					
Support to be used for mounting of all mesh trays on the floor, for example under a raised floor. The height of B33 Support is adjustable from 215 to 370 mm. The upper or lower part can be adjusted in a 90° angle. Material: Steel, HDG.					
B33	215/100/220		174	7332227012355	1149235
Conveyor bracket B17					
Universal fitting to be used when mounting mesh trays along conveyor systems. Material: Steel, HDG.					
B17	35/450/35		56	7332227012928	1149292
Earth connection clamp B18					
Earth connection clamp to be used to mount earth cable onto a chosen wire of the mesh tray. Material: Brass, electrolytically nickel coated.					
B18	15/30/15		2	7321677887163	1149180
End plugs 28E					
End plug to be mounted on Pendant 2F/2FB and on Pendant/fixing rail 24/48 respectively, see below. Intended to provide protection against personal injuries and to make the the ends of the profiles more conspicuous. Material: PP/TPE, orange.					
28E for Vertical piece 2F/2FB and Pendant/fixing rail 24/48	24/30/52		0.5	7321677090211	709021
Safety cap B32					
Safety cap of halogen-free and flame-proof plastic material. To be mounted onto wires sticking out. Bag with 100 pcs. Material: PE.					
B32/3	5/8/5		5	7332227013895	1149389
B32/4	8/10/8		5	7332227013888	1149388
B32/5	8/10/8		4	7332227013666	1149366
B32/6	8/10/9		3	7332227013673	1149367
Mounting spacer B22					
Plastic spacer that fits all mini mesh-tray dimensions. Mounted by snapping the spacer onto the bottom wires. For 3 mm wire diameter. Bag with 10 pcs. Material: PE.					
B22	6/18/18		1.4	7332227015233	1149523
Velcro B51					
Velcro tape intended to attach bundles of cables onto a mesh tray. Length 22.8 m, colour black.					
B51/10	10/22.8		16	7332227186506	1518650
B51/20	20/22.8		32	7332227186513	1518651

P140021



P140022



P140088



P140089



P140000



P140089



P141001



B22/730

P141002



P140048



Steel mesh trays

Hot-dip galvanized - Corrosion class C2-C4

Accessories

Type	Dimensions A/B/C mm		Weight kg/100 pcs	EAN code	Ref. No.
Marking clip B44					
Plastic marking clip, flame-resistant, to be snapped onto the two side wires of the mesh tray. The Equipotential Bonding clip is available in Swedish, English and German. Package of 10 pcs. Material: ABS.					
B44	40/10/90		1	7332227014274	1149427
B44/Potentialutjämning, SE	40/10/90		1	7321677888566	1149428
B44/Equipotential Bonding, GB	40/10/90		1	7321677888573	1149429
B44/Potentialausgleich, DE	40/10/90		1	7321677888580	1149430
Identification tag B40					
Identification tag to be snapped onto mesh tray wires of Ø 5 mm. Package of 10 pcs. Material: ABS.					
B40/Opto	35/8/43		1	7332227014205	1149420
B40/Coax	35/8/43		1	7332227014212	1149421
B40/Pair	35/8/43		1	7332227014229	1149422
B40/Neutral	35/8/43		1	7332227014236	1149423
B40/Pow	35/8/43		1	7332227014243	1149424

P133791



P141014



P133792



P141015



P141016



P141017



P141018



P141019



P141020



Tools

Cable roller B25					
Cable roller intended to facilitate the pulling of cables into the mesh trays. Mounted on the mesh tray by pulling the black knob outwards. When the cable pulled by the cable roller has reached the desired distance, it is moved to the tray by pushing the small metal button to open the cable roller and removing it. Material: Stainless steel AISI316L, plastic.					
B25	210/130/40		35	7332227019552	1653955
Bolt cutter B28					
Bolt cutter with angled clipper cut head for narrow and clean cuts of mesh tray wires.					
B28	140/40/630		272	7332227239981	1623998
Spanner B45					
10 mm combination spanner, open end/flex head end. Material: Chrome vanadium steel.					
B45	15/15/180		7	7332227222006	1622200

B224692



B224643



B224769



Steel mesh trays

Stainless steel AISI 304L - Corrosion class C5-I

Mesh trays, stainless

Type	Dimensions A/B/C mm		Weight kg/100 pcs	EAN code	Ref. No.
------	---------------------	---	-------------------	----------	----------

Mesh trays, 45, 55 and 60 mm high

Mesh cable tray, length 2.5 m. Size 75/55 available both made of ø 4 and 5 mm wire, see dimension table below.
Material: Stainless steel AISI304L.

P140859



53/45	45/53/2500		176	3606480523472	1149613
75x4/55	55/75/2500		190	3606480518539	1149600
75x5/55	55/75/2500		297	3606480523465	1149610
120/60	60/120/2500		318	3606480518546	1149601
220/60	60/220/2500		437	3606480518560	1149602
320/60	60/320/2500		555	3606480518577	1149603
422/60	60/422/2500		772	3606480523489	1149614
522/60	60/522/2500		922	3606480523496	1149615
622/60	60/622/2500		1075	7315881149612	WBE1149616

Mesh trays, 110 mm high

Mesh cable tray, length 2.5 m.
Material: Stainless steel AISI304L.

P140865

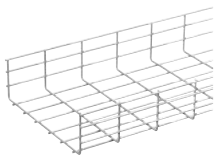

120/110	110/120/2500		443	3606480518584	1149604
220/110	110/220/2500		562	3606485444475	1149605
320/110	110/320/2500		683	3606485444482	1149606
422/110	110/422/2500		922	3606485444499	1149607
522/110	110/522/2500		1075	3606485444512	WBE1149608
622/110	110/622/2500		1116	3606485444505	1149609

Dimension table

B225239

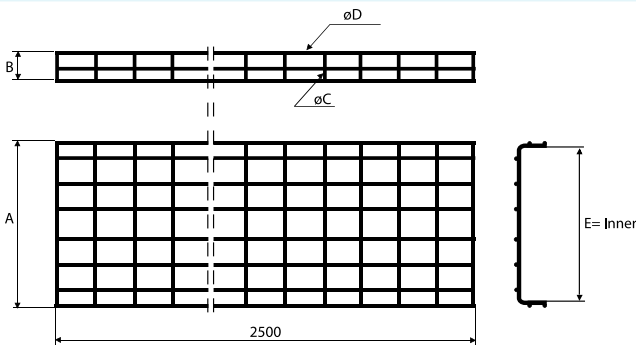

B225240

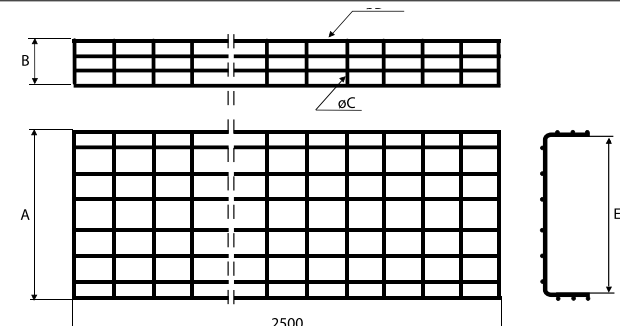

Type	A mm	B mm	C mm	D mm	E mm	Ref. No.
Mesh tray 53/45	53	45	4	4	37	1149613
Mesh tray 75x4/55	75	55	4	4	59	1149600
Mesh tray 75x5/55	75	55	5	5	55	1149610
Mesh tray 120/60	120	60	5	5	100	1149601
Mesh tray 220/60	220	60	5	5	200	1149602
Mesh tray 320/60	320	60	5	5	300	1149603
Mesh tray 422/60	422	60	5	6	400	1149614
Mesh tray 522/60	522	60	5	6	500	1149615
Mesh tray 622/60	622	60	5	6	600	WBE1149616
Mesh tray 120/110	120	110	5	5	100	1149604
Mesh tray 220/110	220	110	5	5	200	1149605
Mesh tray 320/110	320	110	5	5	300	1149606
Mesh tray 422/110	422	110	5	6	400	1149607
Mesh tray 522/110	522	110	5	6	500	WBE1149608
Mesh tray 622/110	622	110	5	6	600	1149609

Steel mesh trays

Stainless steel AISI 316L - Corrosion class C5-I/C5-M

Mesh trays, stainless

Type	Dimensions A/B/C mm		Weight kg/100 pcs	EAN code	Ref. No.
------	---------------------	--	-------------------	----------	----------

Mesh trays, 45, 55 and 60 mm high

Mesh cable tray, length 2.5 m. Size 75/55 available both made of ø 4 and 5 mm wire, see dimension table below.
Material: Stainless steel AISI316L.

53/45	45/53/2500		176	7332227013130	1149313
75x4/55	55/75/2500		190	7332227013000	1149300
75x5/55	55/75/2500		297	7332227013109	1149310
120/60	60/120/2500		318	7332227013017	WBE1149301
220/60	60/220/2500		437	7332227013024	1149302
320/60	60/320/2500		555	7332227013031	1149303
422/60	60/422/2500		772	7332227013147	1149314
522/60	60/522/2500		922	7321677887972	1149315
622/60	60/622/2500		1075	7321677887989	1149316

Mesh trays, 110 mm high

Mesh cable tray, length 2.5 m.
Material: Stainless steel AISI316L.

120/110	110/120/2500		443	7332227013048	1149304
220/110	110/220/2500		562	7332227013055	1149305
320/110	110/320/2500		683	7332227013062	1149306
422/110	110/422/2500		922	7332227013079	1149307
522/110	110/522/2500		1075	7321677887927	1149308
622/110	110/622/2500		1116	7321677887934	1149309

Dimension table

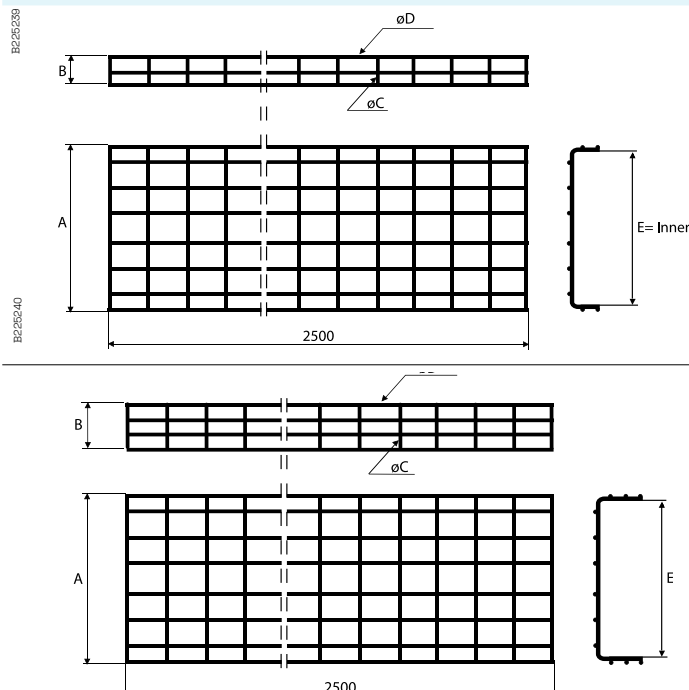

Type	A mm	B mm	C mm	D mm	E mm	Ref. No.
Mesh tray 53/45	53	45	4	4	37	1149313
Mesh tray 75x4/55	75	55	4	4	59	1149300
Mesh tray 75x5/55	75	55	5	5	55	1149310
Mesh tray 120/60	120	60	5	5	100	WBE1149301
Mesh tray 220/60	220	60	5	5	200	1149302
Mesh tray 320/60	320	60	5	5	300	1149303
Mesh tray 422/60	422	60	5	6	400	1149314
Mesh tray 522/60	522	60	5	6	500	1149315
Mesh tray 622/60	622	60	5	6	600	1149316
Mesh tray 120/110	120	110	5	5	100	1149304
Mesh tray 220/110	220	110	5	5	200	1149305
Mesh tray 320/110	320	110	5	5	300	1149306
Mesh tray 422/110	422	110	5	6	400	1149307
Mesh tray 522/110	522	110	5	6	500	1149308
Mesh tray 622/110	622	110	5	6	600	1149309

Steel mesh trays

Stainless steel AISI 316L - Corrosion class C5-I/C5-M

C, G and Z-Mesh trays

Type	Dimensions A/B/C mm		Weight kg/100 pcs	EAN code	Ref. No.
------	---------------------	---	-------------------	----------	----------

C-mesh trays

C-shaped mesh cable tray, length 2.5 m, for use where mounting with long support distances (up to 4 metres) are needed. Material: Stainless steel AISI316L.

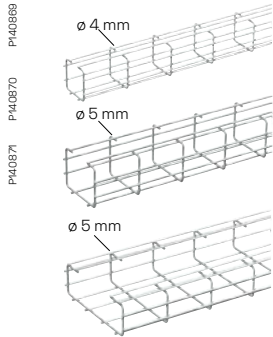

75x75	75/75/2500		253	7332227013321	1149332
120x100	100/120/2500		429	7332227013338	1149333
220x80	80/220/2500		623	7332227013345	1149334

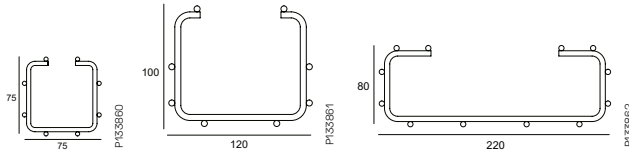

G-mesh trays

G-shaped mesh cable tray, length 2.5 m, for installation in ceilings, onto walls, under desks and for mounting on cable ladders. Material: Stainless steel AISI316L.

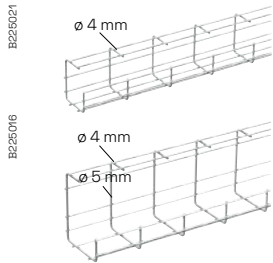

75x95	95/75/2500		260	7332227013383	1149338
120x150	150/120/2500		350	7332227013390	1149339

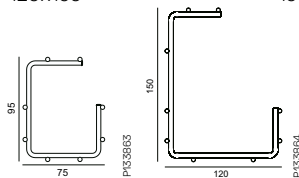

Z-mesh trays

Z-shaped mesh cable tray, length 2.5 m, for environments where regular and thorough cleaning is required. Wire ø 5 mm. Material: Stainless steel AISI316L.

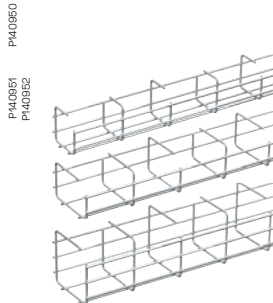

75x75	75/75/2500		201	7332227013406	1149340
120x75	80/120/2500		351	7332227013413	1149341
120x130	130/120/2500		469	7332227013420	1149342

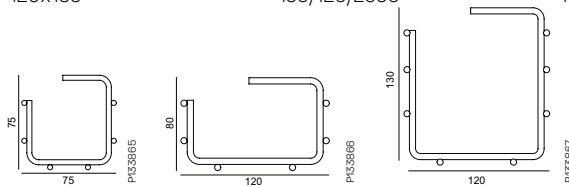

Mini mesh trays

Mini mesh trays B30-D

Mini mesh tray for the routing of cables. Diamond-shaped for good guiding and protection. Mesh tray length 2 m, wire ø 3 mm. Material: Stainless steel AISI316L.



B30-D	24/30/2000		52	7332227013123	1149312
-------	------------	--	----	---------------	----------------

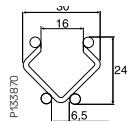

Mini mesh trays B30-U

Mini mesh tray in a space-saving U-shape for the routing of cables. Mesh tray length 2 m, wire ø 3 mm. Material: Stainless steel AISI316L.



B30-U	15/46/2000		52	7332227013253	1149325
-------	------------	--	----	---------------	----------------



Mini mesh trays B30-I

Mini mesh tray in a space-saving plane design for the routing of cables. Mesh tray length 2 m, wire ø 3 mm. Material: Stainless steel AISI316L.











B30-I	6/60/2000		52	7332227013116	1149311
-------	-----------	--	----	---------------	----------------





Steel mesh trays

Stainless steel AISI 316L - Corrosion class C5-I/C5-M

Fittings and joining set

Type	Dimensions A/B/C mm 	Weight kg/100 pcs	EAN code	Ref. No.
Fitting B1				
	Fitting to be used as a wall bracket. It can also be mounted over the centre wires as a carrier of lighting fittings. Can also be used in 90 degree angles or as a joining fitting. Delivered without bolt and nut. Material: Stainless steel AISI316L.			
B1	40/5/80	4.8	7332227013543	1149354
Fitting B2				
	Fitting to be used to join mesh trays. Can also be used in 90 degree angles. Delivered without bolt and nut. Material: Stainless steel AISI316L.			
B2	35/7/25	2	7332227013550	1149355
Fitting B3				
	Fitting to be used when joining wires in horizontal and vertical bends, in four-way and tee-junctions, etc. Delivered with bolt and nut. Material: Stainless steel AISI316L.			
B3	20/29/23	4	7332227013567	1149356
Angled fitting B27				
	Angled fitting for creating T-junctions or for connections to wall, ceiling and floor. Also for bends with adjustable angle. Material: Stainless steel AISI316L.			
B27	85/40/85	13	7332227013697	1149369
Mounting coupler B20				
	Mounting coupler to be used for joining and mounting of mini mesh-wire trays. Material: Stainless steel AISI316L.			
B20	9/19/85	2	7332227013314	1149331
Joining set B52				
	Pre-assembled joining fitting including Fittings B1 and B2, Bolt and Nut B13. Used to join the side sections of all mesh trays. Material: Stainless steel AISI316L.			
B52	41/25/80	8	7332227013536	1149353
Bolt and nut B13				
	Bolt and nut M6x25. Tensi-lock and flange nut M6. Material: Stainless steel AISI316L.			
B13, 50+50 pcs	30/18/18	0.59/bag	7332227013840	1149384
B13, 250+250 pcs	30/18/18	2.90/bag	7332227013857	1149385

Brackets

Bracket B4/B4 Mini				
	Bracket to be used for the mounting of mesh trays 53-622 onto wall and floor. Material: Stainless steel AISI316L.			
B4	85/30/95	15	7332227013574	1149357
B4 Mini	53/23/55	5	7332227013987	1149398
Bracket B4 100/2				
	Bracket to be used for the mounting of mesh trays 422-622 mm. To be installed in pairs in two lines for heavy mesh trays. Intended for extended vertical installation in hygienic areas where a distance is needed for cleaning purposes. Distance to the supporting surface 100 mm. Material: Stainless steel AISI316L.			
B4 100/2	85/95/100	16	3606480531316	CSU794989
Bracket B4 100/4 / B4 Mini 100				
	Bracket to be used for the mounting of mesh trays. Intended for extended vertical installation in hygienic areas where a distance is needed for cleaning purposes. Distance to the supporting surface 100 mm. Material: Stainless steel AISI316L.			
B4 100/4, for mesh trays 220-320 mm	85/95/100	26	3606480531323	CSU794990
B4 Mini 100, for mesh trays 53-120 mm	53/55/100	16	3606480531330	CSU794991

Steel mesh trays

Stainless steel AISI 316L - Corrosion class C5-I/C5-M

Brackets

Type	Dimensions A/B/C mm 	Weight kg/100 pcs	EAN code	Ref. No.
Cantilever arm 50				
Cantilever arm for mounting on walls, pendant/fixing rails or vertical pieces. Material: Stainless steel AISI316L.				
50-100	85/150/40	24	7321677256181	725618
50-150	85/200/40	28	7321677256198	725619
50-200	85/250/40	34	7321677256204	725620
50-250	105/300/40	52	7321677256211	725621
50-300	105/350/40	60	7321677256228	725622
50-400	120/450/50	228	7321677256235	725623
50-500	140/550/50	172	7321677256242	725624
50-600	150/650/50	215	7321677256259	725625
T-bolt 26U				
T-bolt to be used for the mounting of cantilever arm 50 on Pendant/fixingrail 24/48 and vertical piece 2F/2FB. Material: Stainless steel AISI316L.				
26U M8	50/44/18	6.8	3606489579784	CSU795596

Vertical pieces

Vertical piece 2				
Vertical piece to be used for installation of support bracket 3, symmetrical loading. Not suitable for cable ladders KHZV and KHZPV. Can be joined to Pendant/fixing rail 24/34 with Pendant joint 2J. Material: Stainless steel AISI316L.				
2-300	279/80/135	52	7321677255573	725557
2-400	392/80/135	62	7321677255580	725558
2-500	504/80/135	72	7321677255597	725559
2-700	729/80/135	93	7321677255603	725560
2-1000	1022/80/135	120	7321677255610	725561
Vertical piece 2F				
Vertical piece to be used for installation of central suspension bracket D35 and Cantilever arm 50. Can be joined to Pendant/fixing rail 24/48 with Pendant joint 2FJ. Material: Stainless steel AISI316L.				
2F-280	280/80/135	80	7321677255627	725562
2F-505	505/80/135	130	7321677255641	725564
2F-1000	1000/80/135	220	7321677255665	725566
Vertical piece 2FB				
Reinforced vertical piece to be used for installation of central suspension bracket D35 and Cantilever arm 50. Can be joined to Pendant/fixing rail 24/48 with Pendant joint 2FJ. Material: Stainless steel AISI316L.				
2FB-280	280/155/150	113	3606480911514	CSU795338
2FB-505	505/155/150	163	3606480911521	CSU795339
2FB-1000	1000/155/150	253	3606480911538	CSU795340

Ceiling and joining fittings, support

Ceiling bracket 5				
Ceiling bracket to be used for installations with Pendant/Fixing rail 24/48. Screw set 22S included. Material: Stainless steel AISI316L.				
5	100/135/40	35	7321677255733	725573
Pendant/Fixing rail 24/48				
Pendant/Fixing rail for mounting of support brackets, cantilever arms, etc. Material: Stainless steel AISI316L.				
24/48	1000/26/48	175	3606481317872	CSU795566
24/48	2970/26/48	520	7321677285952	728595
Pendant joint 2FJ				
Pendant joint to be used for joining pendant/fixing rails and vertical pieces. Screws M8x16 and nuts included. Material: Stainless steel AISI316L.				
2FJ	200/55/18	46	7321677264858	726485
Pendant bar 1				
Pendant bar to be installed in order to reduce the deflection of heavily loaded vertical pieces. Installed with T-bolt and Expansion bolt. Material: Stainless steel AISI316L.				
1-500	515/166/40	53	3606480911415	CSU795328

Steel mesh trays

Stainless steel AISI 316L - Corrosion class C5-I/C5-M

Screw set

Type	Dimensions A/B/C mm		Weight kg/100 pcs	EAN code	Ref. No.
Screw set 22S					
Screw set to be used for installation of central suspension bracket D35 on Vertical piece 2F/2FB, central suspension bracket D35 and Ceiling bracket 5 on Pendant/fixing rails 24/48, and Pendant/fixing rails back to back. Set including screw MVBF 8x16 and nut M6MF8. Material: Stainless steel AISI316L.					
22S	—		1.9	7321677255825	725582

Ceiling fittings

Ceiling fitting, universal B46					
Universal ceiling fitting intended for mounting of Threaded rod B41 onto ceiling. Material: Stainless steel AISI316L.					
B46	75/30/60		9	7332227015745	1149574
Ceiling fitting, flexible B47					
Flexible ceiling fitting that adjusts to the inclination of the ceiling. Delivered complete with Tensi-lock flange nut. Material: Stainless steel AISI316L.					
B47/M8	65/65/65		13	7332227015752	1149575
B47/M10	65/65/65		13	7332227015769	1149576
Ceiling clamp B48					
Ceiling clamp for hole Ø 22 mm. Delivered complete with Tensi-lock nut and washers. Material: Stainless steel AISI316L.					
B48/M8	20/20/75		6	7332227015721	1149572
B48/M10	20/20/75		7	7332227015738	1149573

Support hooks

Support hook D35/120-220					
Support hook intended for 120-220 mm mesh trays. Material: Stainless steel AISI316L.					
D35/120-220	148/48/94		19	3606480911637	CSU795350
Support hook D35/320-422					
Reinforced support hook intended for 320-422 mm mesh trays. Material: Stainless steel AISI316L.					
D35/320-422	161/48/310		31	7332227013208	1149320
Support hook D35/422-622					
Reinforced support hook intended for 422-622 mm mesh trays. Material: Stainless steel AISI316L.					
D35/522-622	161/48/490		91	3606480911651	CSU795352
Support hook B39					
Support hook for mounting onto a Threaded rod. For tray widths 120-220 and 320-422 respectively. Material: Stainless steel AISI316L.					
B39/120-220	25/50/95		8	7332227013178	1149317
B39/320-422	25/50/290		30	7332227013185	1149318

Threaded rods

Threaded rod B41					
Threaded rod according to metric standard 6G. Material: Stainless steel AISI316L.					
B41/M8	8/8/1000		32	7332227015516	1149551
	8/8/2000		63	7332227015523	1149552
B41/M10	10/10/1000		50	7332227015615	1149561
	10/10/2000		99	7332227015622	1149562

Steel mesh trays

Stainless steel AISI 316L - Corrosion class C5-I/C5-M

Nuts					
	Type	Dimensions A/B/C mm 	Weight kg/100 pcs	EAN code	Ref. No.
P140154	Flange nut B43				
	Flange nut to be mounted onto Threaded rod B41 in order to lock it to the Support hook and the Ceiling fittings. Material: Stainless steel AISI316L.				
	B43/M8, 50 pcs	8/17/17	34	7332227015547	1149554
	B43/M10, 50 pcs	15/20/20	56	7332227015646	1149564
P140155	Distance nut B42				
	Distance nut to be used when joining Threaded rods. Material: Stainless steel AISI316L.				
	B42/M8	30/15/15	1	7332227015554	1149555
	B42/M10	40/20/20	2	7332227015653	1149565
Accessory holders					
P140082	Accessory holder B5 Mini				
	Accessory holder with a universal hole pattern for the mounting of a variety of boxes and outlets. The holder is easy to mount in different directions and angles on a mesh tray. The holder is tightened to the mesh tray by closing the grip around the wires. Material: Stainless steel AISI316L.				
	B5 Mini	140/24/170	20	7332227013376	1149337
P140082	Accessory holder B5				
	Accessory holder without holes or with a universal hole pattern for the mounting of a variety of boxes and outlets. The holder is easy to mount in different directions and angles on a mesh tray. The holder is tightened to the mesh tray by closing the grip around the wires. Material: Stainless steel AISI316L.				
	B5 with holes	120/28/240	43	7332227013581	1149358
B221769	B5 without holes				
	B5 without holes	120/28/240	46	7332227013680	1149368
Accessories					
PTCLC-344	Plate cover B7				
	Mesh tray plate cover, for tray widths acc. to the type designation. Cover length 1250 mm. Material: Stainless steel AISI316L.				
	B7/75	16/80/1250	70	3606481978288	CSU795796
	B7/120	16/125/1250	110	3606481978295	CSU795797
	B7/220	16/226/1250	175	3606481978301	CSU795798
	B7/320	16/326/1250	240	3606481978318	CSU795799
PTCLC-348	B7/422				
	B7/422	16/426/1250	310	3606481978325	CSU795800
PTCLC-348	Spring cover clip B8				
	Spring wire clip for fixing of B7 covers to the DEFEM mesh trays. Allows easy clicking and unclicking. Minimum 4 clips per cover is recommended. Note! Horizontal installation only. For vertical installation consult Wibe Group for advice. Packed in bag of 20 pcs. Material: Stainless 316L.				
P140095	B8				
	B8	44/10/23	0.2	3606481920324	CSU795790
P140095	Separating plate B26				
	L-shaped separating plate, fixed to the mesh tray by bending the flaps around the transversal wires. Material: Stainless steel AISI316L.				
P140097	B26				
	B26	40/30/2500	113	7332227013789	1149378
P140097	Tele-channel B6				
	Tele-channel to be fixed to the mesh tray by bending the flaps around the transversal wires. Material: Stainless steel AISI316L.				
P140097	B6				
	B6	40/50/2500	201	7332227013475	1149347
P140021 P140022	Combi-fittings B21				
	Combi-fitting to be mounted onto cable ladders. Material: Stainless steel AISI316L.				
	B21	250/50/20	45	7332227013598	1149359
P140098	B21 90 degrees				
	B21 90 degrees	120/50/135	45	7332227013918	1149391
P140098	Support B33				
	Support to be used for mounting of all mesh trays on the floor, for example under a raised floor. The height of B33 Support is adjustable from 215 to 370 mm. The upper or lower part can be adjusted in a 90° angle. Material: Stainless steel AISI316L.				
P140098	B33				
	B33	215/100/220	157	7332227013352	1149335

Steel mesh trays

Stainless steel AISI 316L - Corrosion class C5-I/C5-M

Accessories

Type	Dimensions A/B/C mm		Weight kg/100 pcs	EAN code	Ref. No.
Conveyor bracket B17					
Universal fitting to be used when mounting wire trays along conveyor systems. Material: Stainless steel AISI316L.					
B17	35/450/35		55	7332227013925	1149392
Earth connection clamp B18					
Earth connection clamp to be used to mount earth cable onto a chosen wire of the mesh tray. Material: Brass, electrolytically nickel coated.					
B18	15/30/15		2	321677887163	1149180
End plugs 28E					
End plug to be mounted on Pendant 2F/2FB and on Pendant/fixing rail 24/48 respectively, see below. Intended to provide protection against personal injuries and to make the the ends of the profiles more conspicuous. Material: PP/TPE, orange.					
28E for Vertical piece 2F/2FB and Pendant/fixing rail 24/48	24/30/52		0.5	7321677090211	709021
Safety cap B32					
Safety cap of halogen-free and flame-proof plastic material. To be mounted onto wires sticking out. Bag with 100 pcs. Material: PE.					
B32/3	5/8/5		5	7332227013895	1149389
B32/4	8/10/8		5	7332227013888	1149388
B32/5	8/10/8		4	7332227013666	1149366
B32/6	8/10/9		3	7332227013673	1149367
Mounting spacer B22					
Plastic spacer that fits all mini mesh-tray dimensions. Mounted by snapping the spacer onto the bottom wires. For 3 mm wire diameter. Bag with 10 pcs. Material: PE.					
B22	6/18/18		1.4	7332227015233	1149523
Radius limiter B34					
Radius limiter that limits the bend radius for sensitive cables. The radius limiter is mounted from below by using the locking stick. Material: Stainless steel AISI316L.					
B34/75	40/80/75		9	7332227015370	1149537
B34/120	40/80/115		11	7332227015318	1149531
B34/220	40/80/215		22	7332227015325	1149532
B34/320	40/80/315		33	7332227015332	1149533
B34/422	40/80/415		45	7332227015349	1149534
B34/522	40/80/515		58	7332227015356	1149535
B34/622	40/80/615		68	7332227015363	1149536
Velcro B51					
Velcro tape intended to attach bundles of cables onto a mesh tray. Length 22.8 m, colour black.					
B51/10	10/22.8		16	7332227186506	1518650
B51/20	20/22.8		32	7332227186513	1518651

Steel mesh trays

Stainless steel AISI 316L - Corrosion class C5-I/C5-M

Accessories

Type	Dimensions A/B/C mm		Weight kg/100 pcs	EAN code	Ref. No.
Marking clip B44					
Plastic marking clip, flame-resistant, to be snapped onto the two side wires of the mesh tray. The Equipotential Bonding clip is available in Swedish, English and German. Package of 10 pcs. Material: ABS.					
B44	40/10/90		1	7332227014274	1149427
B44/Potentialutjämning, SE	40/10/90		1	7321677888566	1149428
B44/Equipotential Bonding, GB	40/10/90		1	7321677888573	1149429
B44/Potentialausgleich, DE	40/10/90		1	7321677888580	1149430
Identification tag B40					
Identification tag to be snapped onto mesh tray wires of Ø 5 mm. Package of 10 pcs. Material: ABS.					
B40/Opto	35/8/43		1	7332227014205	1149420
B40/Coax	35/8/43		1	7332227014212	1149421
B40/Pair	35/43/8		1	7332227014229	1149422
B40/Neutral	35/8/43		1	7332227014236	1149423
B40/Pow	35/8/43		1	7332227014243	1149424

P43791



P44014



P43792



P44016



P44016



P44017



P44018



P44019



P44020



Tools

Cable roller B25					
Cable roller intended to facilitate the pulling of cables into the mesh trays. Mounted on the mesh tray by pulling the black knob outwards. When the cable pulled by the cable roller has reached the desired distance, it is moved to the tray by pushing the small metal button to open the cable roller and removing it. Material: Stainless steel AISI316L, plastic.					
B25	210/130/40		35	7332227019552	1653955
Bolt cutter B28					
Bolt cutter with angled clipper cut head for narrow and clean cuts of mesh tray wires.					
B28	140/40/630		272	7332227239981	1623998
Spanner B45					
10 mm combination spanner, open end/flex head end. Material: Chrome vanadium steel.					
B45	15/15/180		7	7332227222006	1622200

B653955



B224943



B224769



The right surface treatment

– crucial for a successful outcome

A cable support installation is considered to be a long-lasting solution and the life expectancy is dependent on the environment in which it is placed. A thorough investigation of the setting in terms of corrosion, pollution, humidity, salt, sanitary regulations etc will help you make the best choice. Our range of mesh trays and accessories covers all types of surface treatments, enabling a reliable, cost-efficient and long-lasting cable support solution.

C1 Electro-galvanized

Indoor environments: Schools, shops, hotels, offices, sports halls etc.

- Very low environmental corrosion.
- Heated areas.
- Arid atmosphere.
- Insignificant quantities of pollutant.
- ISO 2081.

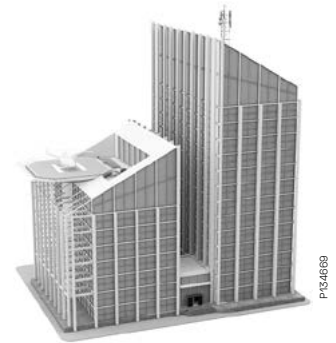

C2 Pre-galvanized

Partly outdoor environments: Industries, sports halls, warehouses, shops, rural outdoor areas etc.

- Low environmental corrosion.
- Non-heated areas with fluctuating levels of temperature and humidity.
- Few instances of condensation and low levels of airborne pollution.
- EN 10346

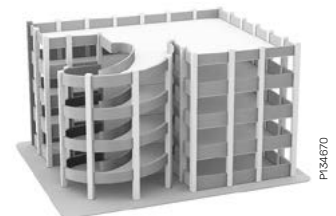

C3 Hot-dip galvanized

Indoor- and outdoor environments: Urban and light industrial areas, breweries, dairies, laundries etc.

- Average environmental corrosion.
- Areas with average levels of humidity and some airborne pollution caused by production processes.
- Atmospheres containing some salt or average levels of airborne pollution.
- EN-ISO1461/EN 10346 (Z+)

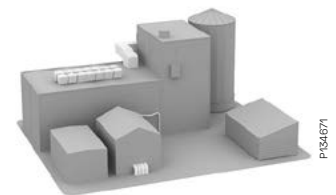

C4 Hot-dip galvanized

Indoor- and outdoor environments: Chemical plants, industrial and coastal areas, swimming pools, farms, dockyards etc.

- High environmental corrosion.
- Areas with high levels of humidity and considerable airborne pollution.
- Atmospheres with average salt content or discernible levels of airborne pollution.
- EN-ISO1461



P134672

C5-I Stainless steel AISI 304L

Indoor- and outdoor environments: Chemical and heavy industries, tunnels, swimming pools, dockyards etc.

- Very high (industrial) environmental corrosion.
- Areas with almost permanent condensation, large quantities of airborne pollution, high levels of humidity and aggressive atmospheres.
- EN 1.4301 acc. to EN 10088/AISI 304L



P134675

C5-M Stainless steel, AISI 316L

Indoor- and outdoor environments: Heavy industries, coastal and offshore areas, purifying plants etc.

- Very high (marine) environmental corrosion.
- Areas with almost permanent condensation and large quantities of airborne pollution. Atmospheres with high salt content.
- EN 1.4404 acc. to EN 10088/AISI 316L

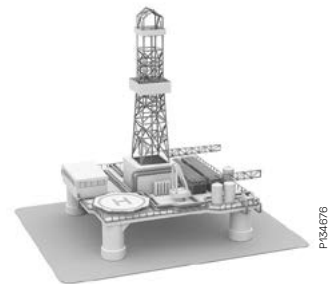

P134676

Technical information

Corrosion classes

The life expectancy of a cable support system is dependent on the environment in which it is placed. Therefore, it is important to establish the corrosive properties of an environment to ensure that the right treatment and the right material are chosen. Do not use components finish above of the corrosion class targeted. The table below shows various corrosion classes. As a guide, we have included the surface treatment recommended by Wibe Group for

the different classes. On the next page, we briefly outline the various surface treatments and materials. As regards environmental corrosion, a steel design component can usually be assigned to one of the corrosion classes (C1 to C5-M) as shown in table A. Reference values for the average level of corrosion in steel and zinc are given in table B. The corrosion classes comply with those stipulated in SS-EN ISO 12944-2.

Table A

Corrosion classes as stipulated by SS-EN ISO 12944-2 with atmospheric corrosion levels and examples of the environment in which they are most suitable for use.

Corrosion class	Environmental corrosion	Examples of typical environments in temperate climates (informative)		Wibe Group designation	
		Outdoors	Indoors		
C1	Very low	–	Heated areas with arid atmosphere and insignificant quantities of pollutant, e.g. offices, shops, schools and hotels.	Electro-galvanized DIN 50961/ISO 2081	
C2	Low	Atmospheres with low levels of airborne pollution. Rural areas.	Non-heated areas with fluctuating levels of temperature and humidity. Few instances of condensation and low levels of airborne pollution, e.g. sports halls and warehouses.	Pre-galvanized Z 275 in accordance with SS-EN 10327:2004	
C3	Average	Atmospheres containing some salt or average levels of airborne pollution. Urban and light industrial areas. Areas affected by coastal conditions.	Areas with average levels of humidity and some airborne pollution resulting from production processes, e.g. breweries, dairies, laundries.	Hot-dip galvanized after manufacture in accordance with EN-ISO 1461:2009	Zinc+ coating
C4	High	Atmospheres with average salt content or discernible levels of airborne pollution. Industrial and coastal areas.	Areas of high humidity and considerable airborne pollution as the result of production processes, e.g. chemical plants, swimming pools and dockyards.		
C5-I	Very high (industrial)	Industrial areas with high levels of humidity and aggressive atmospheres.	Areas with almost permanent condensation and large quantities of airborne pollution.	Zinkpox® HDG+powder coating	Thermoplastic coating*
C5-M	Very high (marine)	Coastal and offshore areas with high salt content.	Areas with almost permanent condensation and large quantities of airborne pollution.	Stainless steel SS2333 AISI 304	
				Stainless steel SS2348 AISI 316L	

* Only for Cable Ladders and Cable Trays
** Only for Cable Ladders

Table B

Mass losses for steel and zinc in various corrosion classes

Corrosion class	Mass loss per surface unit and thickness reduction (1 year of exposure) ¹			
	Steel		Zinc	
	Mass loss (g/m ²)	Thickness reduction (µm)	Mass loss (g/m ²)	Thickness reduction (µm)
C1	≤ 10	≤ 1.3	≤ 0.7	≤ 0.1
C2	> 10 to 200	> 1.3 to 25	> 0.7 to 5	> 0.1 to 0.7
C3	> 200 to 400	> 25 to 50	> 5 to 15	> 0.7 to 2.1
C4	> 400 to 650	> 50 to 80	> 15 to 30	> 2.1 to 4.2
C5-I	> 650 to 1500	> 80 to 200	> 30 to 60	> 4.2 to 8.4
C5-M	> 650 to 1500	> 80 to 200	> 30 to 60	> 4.2 to 8.4

¹Corrosion speed is generally higher when the material is first exposed

Technical information

Surface treatments

Defem Mesh Trays - Technical and material data

Steel wire

Specification: C9D acc. to EN 10016-2
AISI 316L acc. to ASTM/EN 1.4404 acc. to EN 10088-3

Density: 7.7-7.85 kg/m³

Surface treatment: • Electro-galvanized (>8 µm): EN ISO2081
• Hot-dip galvanized (>70 µm): EN ISO 1461
• Pickling (AISI 316L)

Steel sheet

Specification: S235 acc. to EN 10025-2
AISI 316L acc. to ASTM/EN 1.4404 acc. to EN ISO 1008-2

Density: 7.7-7.85 kg/m³

Surface treatment: • Electro-galvanized (>8 µm): EN ISO 2081
• Hot-dip galvanized (55-70µm): EN ISO 1461
• Pickling (Stainless steel)

Resistance to impact	20 J (IEC 61537)
----------------------	------------------

Temperature range	From -20°C to +90°C
-------------------	---------------------

Electro-galvanized

Products are manufactured in accordance with ISO 2081. Such products are intended for use only in warm, dry areas with negligible pollutant levels.

Pre-galvanized

Products are manufactured from Z 275 pre-galvanized sheet steel in accordance with SS-EN 10346. Under normal conditions, surface sections created during cutting and drilling will repair themselves, providing superb anti-corrosion protection.

Hot-dip galvanized

Wibe Group has one of the most modern hot-dip galvanization plants in the Nordic countries. The hot-dip process is continuous, guaranteeing a high and even quality. The manufactured products are hot-dip galvanized in accordance with EN-ISO 1461 whilst nuts and bolts are hot-dip galvanized in accordance with SS-EN ISO 10684. This form of galvanization affords very good value-for-money anti-corrosion protection in atmospheres with a pH value of between 6 and 13. However, in acidic environments where pH levels fall below 6 and in alkaline environments where the pH value exceeds 13, the protective zinc layer breaks down relatively quickly. When cuts/perforations or other kind of operation that damage or remove coating in HDG items suitable to be installed in aggressive corrosion class, must be repaired with a zinc rich paint.

Stainless steel

Products manufactured in accordance with AISI 304 acc. to ASTM/1.4301 acc. to EN 10088-3 or AISI 316L acc. to ASTM/1.4404 acc. to EN 10088-3 are designed for use in highly aggressive environments, either indoors or out- doors, on industrial sites where there are high levels of potent airborne pollution such as in certain chemical industries, cellulose-related industries, refineries or artificial fertilizer factories, high humidity tunnels, etc. Stainless steel products are also ideal for use in environments where special hygiene requirements are in force, such as dairies, abattoirs, other food industries and pharmaceutical factories.

Stainless steel AISI 304L or AISI 316L

The deciding factor in choosing between stainless steel AISI 304L or AISI 316L is the aggressiveness of the environment in which it is to be used, and for this atmospheric chlorine content plays a significant role. Environments with a high chlorine content - coastal areas being a prime example - are aggressive and

usually require the use of AISI 316L materials. When assessing the needs of factories, consideration should be given to the materials previously used to suspend equipment such as pipe tubing, and from this determine whether stainless steel AISI 304L or AISI 316L material is required.

Factors to consider when installing Stainless Steel Mesh trays

- 1. Transport/handling** - Make sure that no iron objects come into contact with the stainless steel products.
- 2. Storing** - Never store stainless steel products close to where iron products are machined, for example close to cutting and grinding operations.
- 3. Welding** - Welding during installation should be avoided where possible. If welding must be performed, make sure that only methods suitable for stainless steel are used.
- 4. Tools** - When cutting or grinding, always use cutting wheels and grinding tools which are free from iron. Do not use tools that have been previously used for cutting or grinding products containing iron. When drilling, use an HSS-drill. To maximize the useful life of the drill, employ a cooling fluid during drilling. When installing, conventional assembly tools can be used. However, when using a nut tightener, ensure that the thread is first lubricated to prevent jamming.

It is not recommended to mix untreated or galvanized products with stainless steel, in case of doubt contact Wibe Group.

- 5. Measures** - If a blue annealing appears when cutting, grinding or drilling, remove it with pickling paste, making sure that the paste is then carefully washed away with water. If selective corrosion appears it can be removed by:
 - a) Washing away with water (high-pressure if possible).
 - b) Polishing with a cleaning cloth or a fine emery paper (wet or dry) and washing with water.
 - c) Grinding with a fine-grained wheel and washing with water.
 - d) Pickling with pickling paste, making sure that the pickling paste is then carefully washed away with water.
- 6.** When using pickling paste or similar products, always study the safety code for the product prior to use.

Technical information

Potential balancing

Electrical continuity and earthing

The standard EN 61537 establishes that for trays with electrical continuity characteristics (metal), this continuity should be guaranteed by means of an equipotential connection and one or several connections to earth in accordance with the use of the tray system.

The impedance must not exceed:
 - 50 mΩ through the joint.
 - 5 mΩ x metre of tray.

The metre length and joining systems for the different sections that Wibe Group has, as well as the joints of the different accessories supplied, comply with the electrical continuity test established in the

forementioned standard, guaranteeing the impedance established. To guarantee these impedance values tightening torque values of no less than 5 Nm are recommended, always using the joints recommended for each tray type, and taking sizes into account.

To guarantee a safe installation, Wibe Group recommends a proper earthing of all the elements that make up the system (sections and accessories), using the accessories designed specifically for this purpose. Ensure that all connections are well fixed and proper values are matching according to local legislation

Electro-galvanized and Hot-dip galvanized

The applications below are approved only in combination with copper cable.

Width 53, 75x4, 75x5, 120

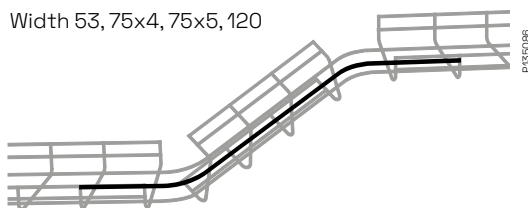

Width 53, 75x4

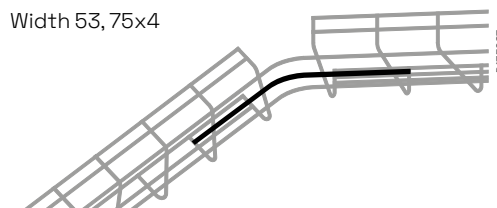

Stainless AISI 316L

Mesh Trays in the dimensions 53, 75x4, 75x5 and 120 shall always be equipped with copper cable.

The applications below are approved only in combination with copper cable.

Width 220

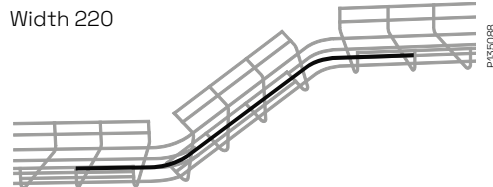

Width 220

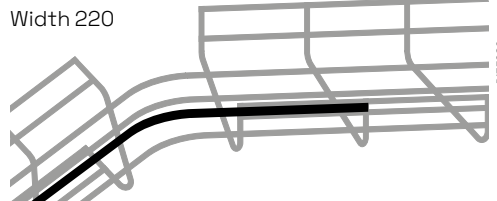

Width 220, 320

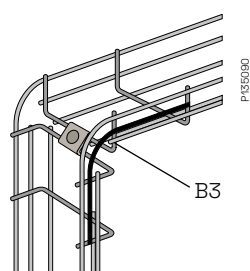

Width 220, 320, 422, 522, 622

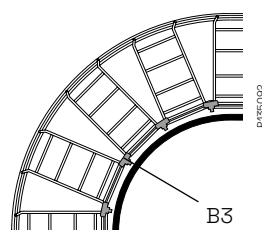
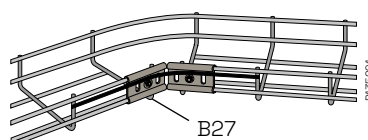

Technical information

Potential balancing

To meet the demands for conductivity in these cases, a copper cable dimensioned according to local regulations has to be installed as shown in the adjoining drawing. End terminals at the cable are recommended in environments where there is a risk of corrosion.

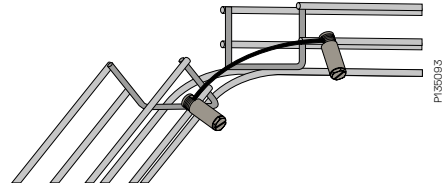

Article/Material	Art. no.
Marking clip B44, Equipotential bonding Flame resistant plastics	11 494 29



Article/Material	Art. no.	Max cable area mm ²
Earth Connection Clamp B18 Brass/Nickel anodized	11 491 80	25



Measured values on real installations

Resistance/Conductivity in mΩ/5 m (including Joining fitting).

A Mesh Tray	B Joints	Electro galv.		Hot Dip galvanized	
		A Tray	B Joints	A Tray	B Joints
		(mΩ/m)	(mΩ)/set of joint	(mΩ/m)	(mΩ)/set of joint
		5 mΩ/m**	50 mΩ/pcs**	5 mΩ/m**	50 mΩ/pcs**
622/110	2xB52 + 3 set B2	0.71*	0.2*	0.9*	0.2*
622/60	2xB52 + 3 set B2				
522/110	2xB52 + 3 set B2				
522/60	2xB52 + 3 set B2				
422/110	2xB52 + 2 set B2	0.71	0.2	0.9	0.2
422/60	2xB52 + 2 set B2				
320/110	2xB52 + 2 set B2	0.88*	0.24*	1.44*	0.56*
320/60	2xB52 + 2 set B2				
220/110	2xB52				
220/60	2xB52	1.14*	0.36	1.44	
120/110	2xB52				
120/60	2xB52	2.27*	0.72*	0.4*	
75x5/55	2xB52				
75x4/55	2xB52	2.55	0.72	2.53*	
53/45	2xB52				
		2.67	0.72	2.53	0.56
		2.65	0.49	2.6	0.52

*Size not tested, assuming same value than previous narrower tray.
Obtained Impedance values from test report: SP_F205777.
For products outside of table, please contact Technical Department.
**Limit value according to standard.

Technical information

Electro-magnetic compatibility EMC

Electromagnetic Compatibility

Wibe Group has performed measurements at EMC Services in Gothenburg regarding EMC requirements, report RE-10273-17181/TR-10024-16723.

The results show that the shielding performance of both incoming and emitted fields is good concerning Defem mesh trays.

When correctly installed Defem mesh tray products the equipotential bounding is guaranteed.

Recommended installation examples

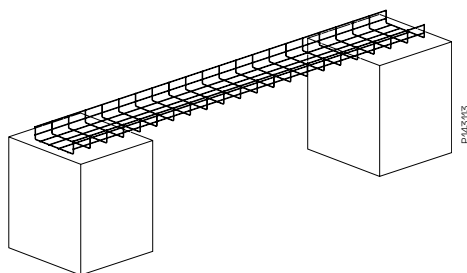

Metal against metal connection
- the ultimate installation

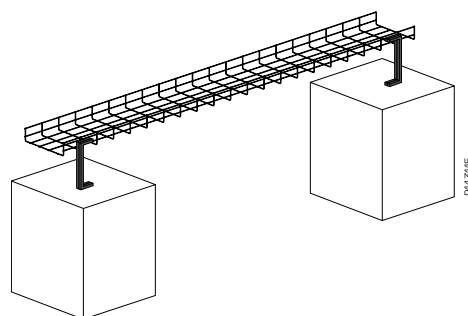

Short double connection
- realistic installation

Not recommended installation examples

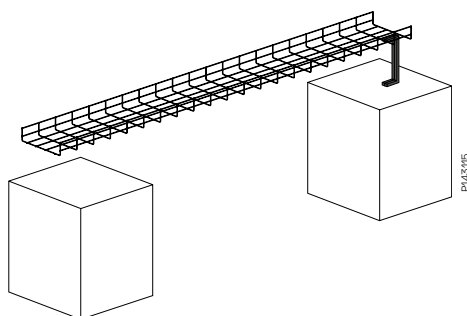

Single connection
- poor installation

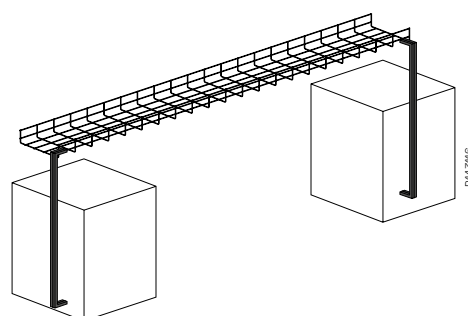

Long double connection
- in best case EMC neutral

Technical information

Quality



The Defem mesh trays meet the toughest product standards:

IEC 61537
DIN 4102-12 for fire resistance E30-E90
NEMA VE 1/CSA 22.2

Tests and certificates	Test made by
Measurements of resistance value from different combinations of Defem Mesh tray and Defem U-bar. Report no. LNKM 036 99.	Telia, Sweden
Tests with Category 5 and 6 cables, in room temperature and in a climatic room with different loads, up to 43 layers, about 250 mm. Report no. Danak-19J0698/ Delta K311126.	Delta Institute, Denmark
EMC characteristics. Report n° TR-10024-16723.	EMC Services Elmiljöteknik AB, Sweden
EMC Performance- Shielding test Report n° RE-10273-17181.	EMC Services Elmiljöteknik AB, Sweden
Tests with fibre patch cord with 2 mm thickness. In room temperature with different loads corresponding to layers of patch cord up to 300 mm. Report n° MHN06514B.	Schenker/Telia Sonera, Sweden
Test Concerning fire resistance DIN 4102-12, E30-E60-E90, ABP P-MPA-E-13-003.	MPA NRW, Germany
Test Concerning fire resistance according to EN 1363-1. Report n° Zp-05-01.02.003.	Pavus, Czech Rep.
Defem Mesh tray as conductor of equipotential bonding according to IEC 61537,11:1. Electrical Continuity: SP F205777 Vibration: SP 94 F, 20903	SP, Sweden
Defem Mesh tray is tested according to Underwriters Laboratories - UL E212854.	UL, USA, Canada
Defem Mesh tray is approved by Det Norske Veritas (DNV) for offshore and ship-yard use, TAE00000MR.	DNV, Norway

Management system - Quality and Environment

Wibe Group has a third-party certified management system for quality and environment in accordance with OHSAS ISO 50001:2011, ISO 45001:2018, ISO 9001:2015 and ISO 14001:2015.

CE-marking of products

The CE-marking of products is placed on the product or on the packing according to "Declaration of Conformity" (DOC), applicable to Wibe Group Cable Support System.

Low voltage directive 2014/35/EU

Wibe Group fulfills the demands according to the harmonized standard EN 61537.

Technical information

Loading capacity

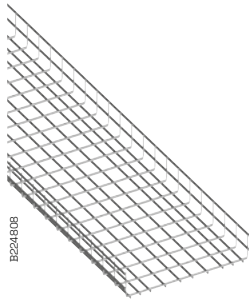

Safe working-load

The safe working-load is determined according to the standard IEC 61537 by using the test type I. See diagrams below.

- The load is uniformly distributed along the mesh trays
- Free location of joints between supports
- The safety working-load value is given when: – the longitudinal deflection is $\leq 1\%$ of the span between brackets – the transversal deflection is $\leq 5\%$ of the width of the mesh tray.

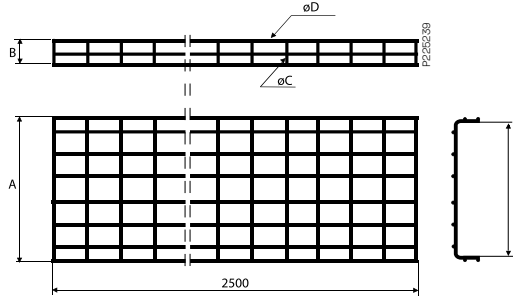

Type	A mm	B mm	C mm	D mm	E mm
Mesh tray 53/45	53	45	4	4	37
Mesh tray 75/55	75	55	4	4	59
Mesh tray 75/55	75	55	5	5	55
Mesh tray 120/60	120	60	5	5	100
Mesh tray 220/60	220	60	5	5	200
Mesh tray 320/60	320	60	5	5	300
Mesh tray 422/60	422	60	5	6	400
Mesh tray 522/60	522	60	5	6	500
Mesh tray 622/60	622	60	5	6	600

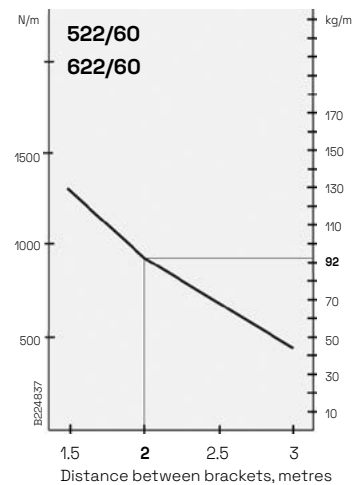
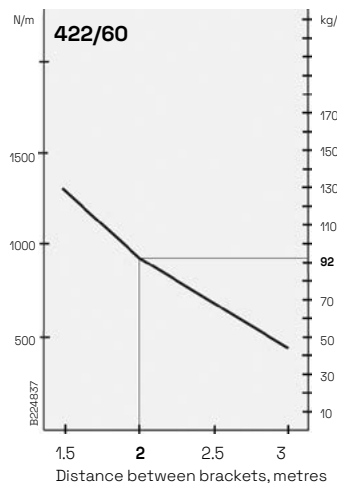
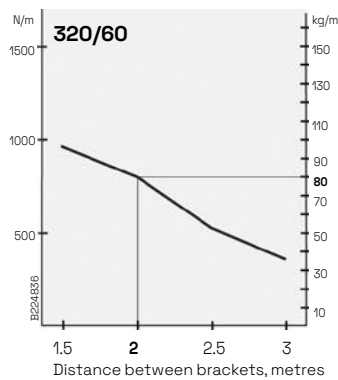
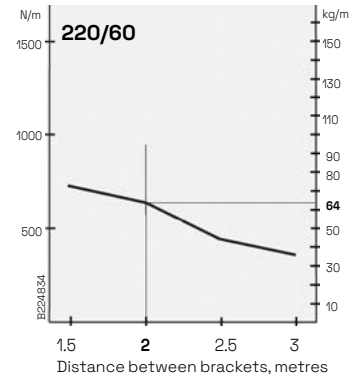
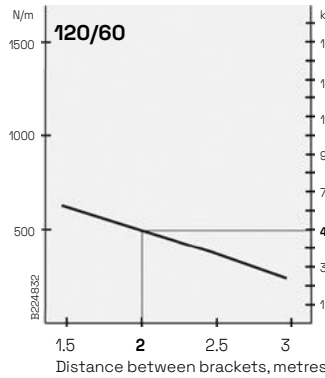
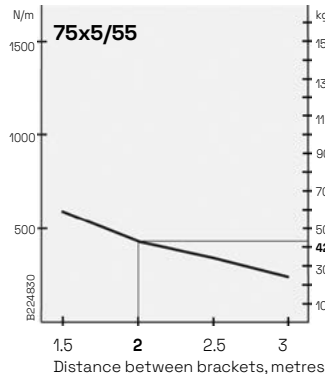

Technical information

Loading capacity

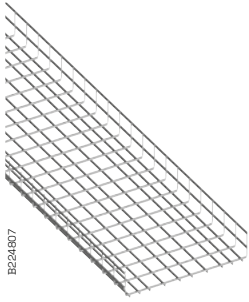

Safe working-load

The safe working-load is determined according to the standard IEC 61537 by using the test type I. See diagrams below.

- The load is uniformly distributed along the mesh trays
- Free location of joints between supports
- The safety working-load value is given when: – the longitudinal deflection is $\leq 1\%$ of the span between brackets – the transversal deflection is $\leq 5\%$ of the width of the mesh tray.

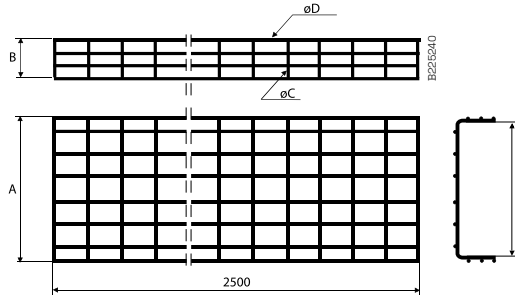

Type	A mm	B mm	C mm	D mm	E mm
Mesh tray 120/110	120	110	5	5	100
Mesh tray 220/110	220	110	5	5	200
Mesh tray 320/110	320	110	5	5	300
Mesh tray 422/110	422	110	5	6	400
Mesh tray 522/110	522	110	5	6	500
Mesh tray 622/110	622	110	5	6	600

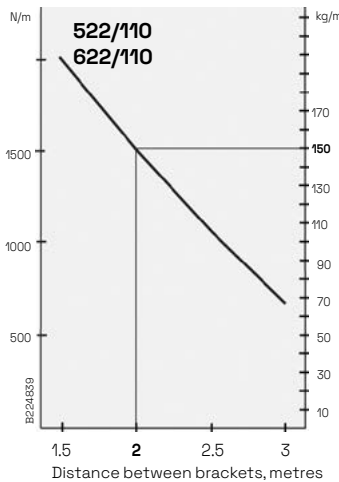
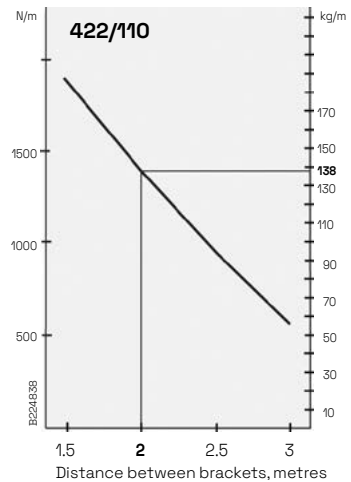
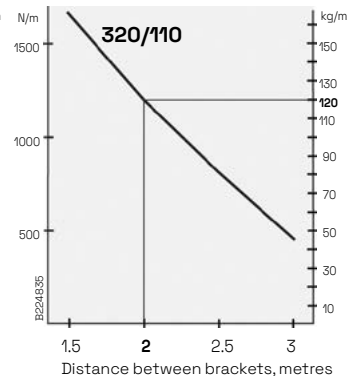
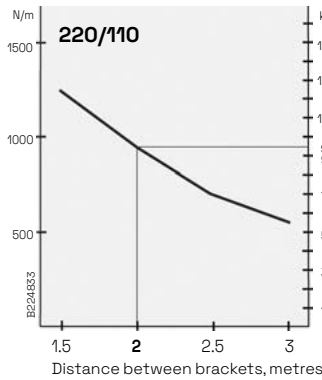
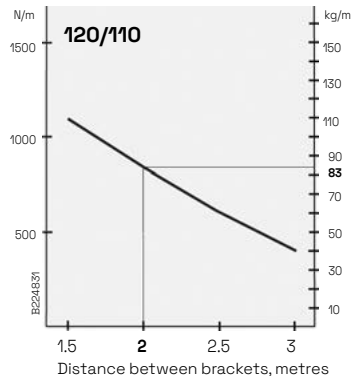

Technical information

Use and installation

C-Mesh tray

For use where mounting with long support distances (up to 4 metres) are needed.

C-Mesh tray 75x75

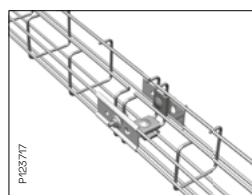
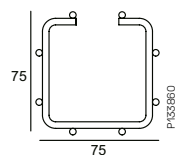
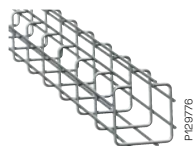

Joining of two C-Mesh trays 75x75.

C-Mesh tray 120x100

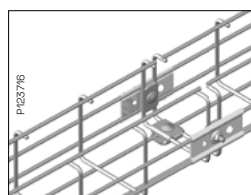
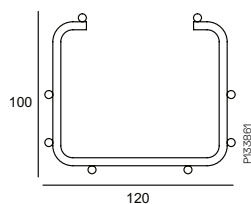

Joining of two C-Mesh trays 120x100.

C-Mesh tray 220x80

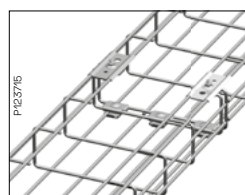
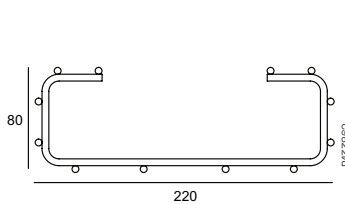

Joining of two C-Mesh trays 220x80.

G-Mesh tray

For installation in ceilings, onto walls, under desks and mounting on cable ladders.

G-Mesh tray 75x95

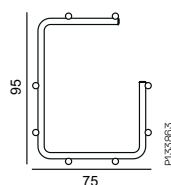
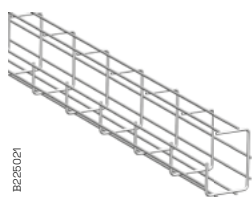

For mounting in ceilings, under desks etc. Fitting B1 is used.

G-Mesh tray 120x150

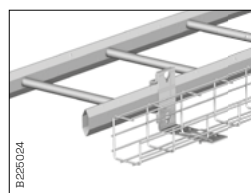
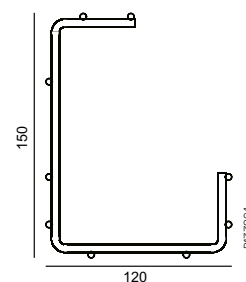
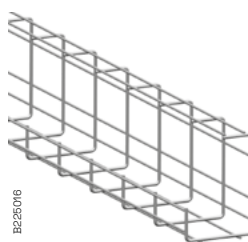

G-Mesh tray mounted on cable ladder, Combi fitting B21 90° is used.

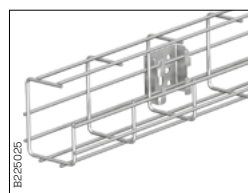

Bracket B4 can also be used for mounting onto floor, wall or ceiling.

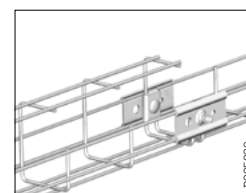

Fittings B1 and B2 are used for joining the mesh trays. Example of joining G-mesh tray with standard mesh tray

Technical information

Use and installation

Z-Mesh tray

For environments where regular and thorough cleaning is required.

Z-Mesh tray 75x75



Z-Mesh tray 120x80



Z-Mesh tray 120x130

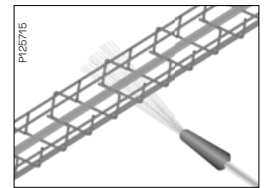
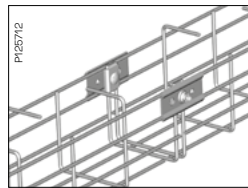
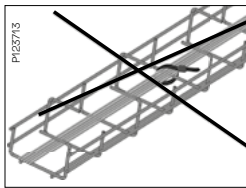
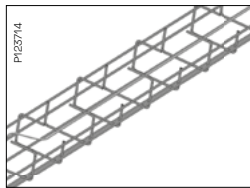
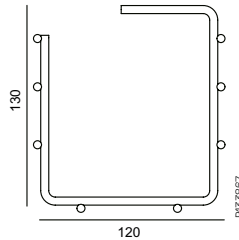
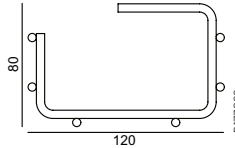
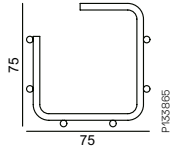

The cable is routed in a zigzag pattern inside the Z-Mesh tray.

No cable ties are needed, not even in vertically mounted trays.

Fittings B1 and B2 are used for joining of Z-Mesh trays.

The non-bundled cables will stay in place during cleaning.

Mini Mesh B30-D

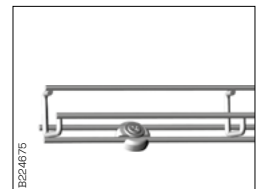
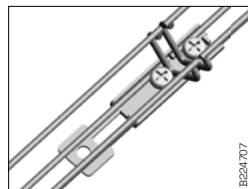
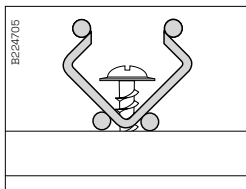
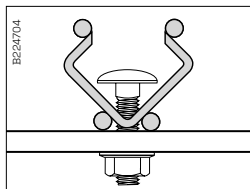
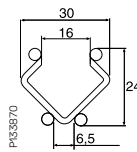
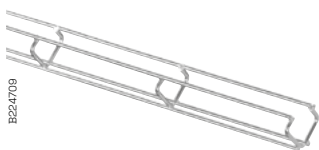

Can be mounted with Bolt and Nut B13.

Can be mounted with suitable screw for wood, concrete etc.

Two Mini Mesh B30-D joined with Mounting coupler B20.

B30-D mounted onto Mounting spacer B22.

Technical information

Use and installation

Mini Mesh B30-U

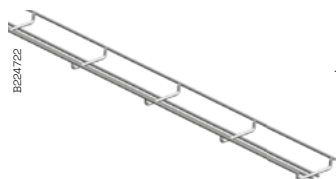

B224722

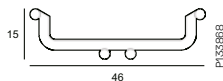

P133869



B224677

B30-U mounted onto Mounting spacer B22.

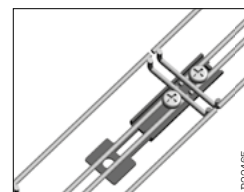

B22465

Two Mini Mesh B30-U joined with Mounting coupler B20.

Mini Mesh B30-I

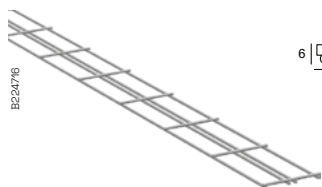

B224776

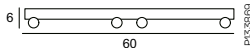

P133869



B224678

B30-I mounted onto Mounting spacer B22.



B224664

B30-I mounted onto cable ladder.

Technical information

Use and installation

Mounting coupler B20

Used for joining and mounting of Mini Mesh Mesh trays.

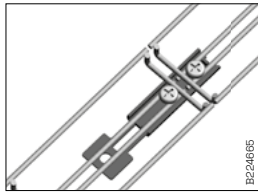
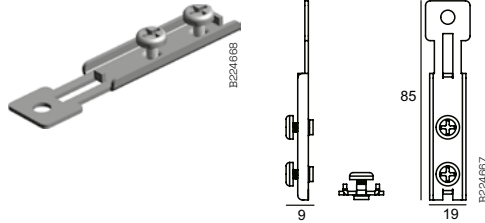

Used for joining of Mini Mesh Trays.

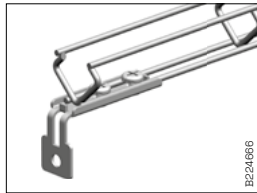

Can be used for mounting of Mini Mesh trays to ceiling, floor and onto wall.

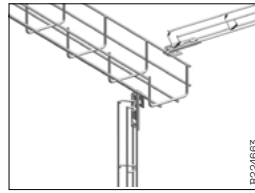

The mounting coupler can be used for vertical and horizontal mounting of Mini Mesh trays onto mesh trays and cable ladders.

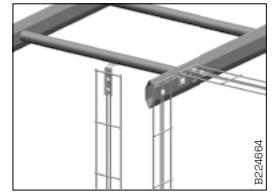

Mounting spacer B22

Plastic Spacer that fits all Mini Mesh dimensions. Easy to mount, just snap the spacer onto the bottom wires.

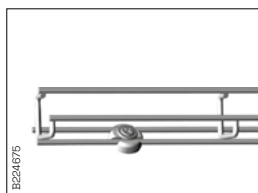
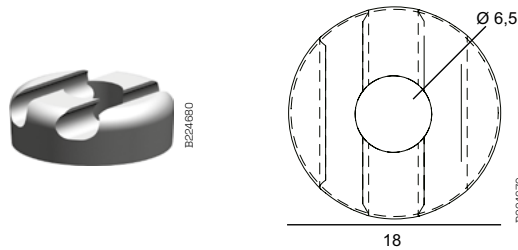

Front view of Mounting Spacer B22 attached to Mini Mesh.



Side view of Mounting Spacer. B22 attached to Mini Mesh-D.

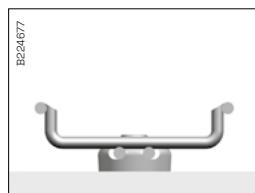

Side view of Mounting Spacer. B22 attached to Mini Mesh-U.



Side view of Mounting Spacer. B22 attached to Mini Mesh-I.

Technical information

Use and installation

Recommended couplers

For joining Mesh trays

Mesh tray size	Side joining	Central joining
53 - 220	2xB1 + 2xB2 + 2xB13 or 2xB52	Not required
320	2xB1 + 2xB2 + 2xB13 or 2xB52	2xB2 + 1xB13
422	2xB1 + 2xB2 + 2xB13 or 2xB52	4xB2 + 2xB13
522 - 622	2xB1 + 2xB2 + 2xB13 or 2xB52	6xB2 + 3xB13

Fitting B1

Delivered without bolt and nut.

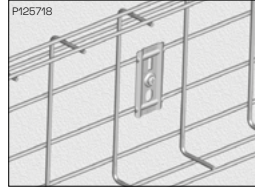
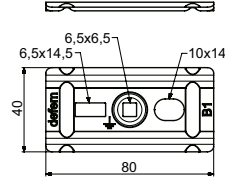

Fitting B1 can be used as a wall bracket.

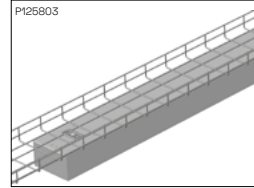

Fitting B1 can be mounted over the centre wires as carrier of lighting fittings.

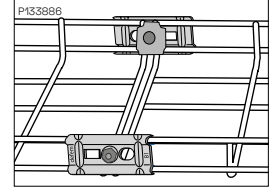

Mesh tray 53 to 220 is joined with:
2 pcs of Fitting B1
2 pcs of Fitting B2
2 pcs of Bolt and Nut B13

Fitting B2

Delivered without bolt and nut.

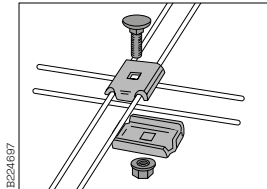
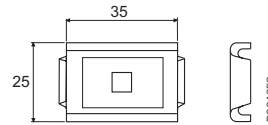

For joining in bottom of tray:
2 pcs of Fitting B2
1 pc of Bolt and Nut B13.

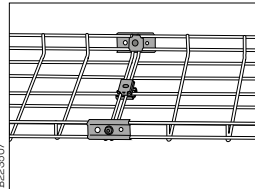

Mesh tray 320 is joined with
2 pcs of Fitting B1
4 pcs of Fitting B2
3 pcs of Bolt and Nut B13.

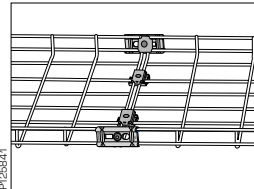

Mesh tray 422 is joined with
2 pcs of Fitting B1
6 pcs of Fitting B2
4 pcs of Bolt and Nut B13

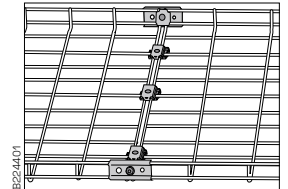

Mesh tray 522 and 622 is joined with
2 pcs of Fitting B1
8 pcs of Fitting B2
5 pcs of Bolt and Nut B13.

90° angling with Fitting B1 och B2

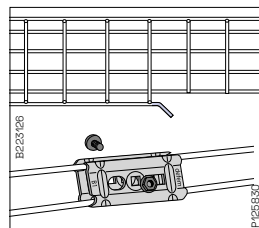

To obtain a softer inner angle, 2 Fittings B1 can be mounted with Bolt and Nut B13.

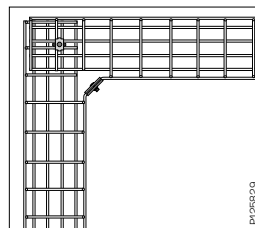

Mesh tray 53 to 220 are joined with:
2 pcs of Fitting B1
2 pcs of Fitting B2
2 pcs of Bolt and Nut B13

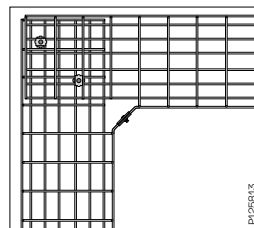

Mesh tray 320 and 422 are joined with:
2 pcs of Fitting B1
4 pcs of Fitting B2
3 pcs of Bolt and Nut B13

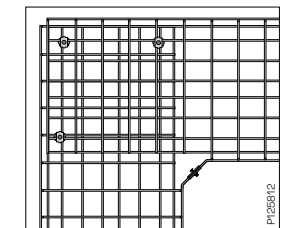

Mesh tray 522 and 622 are joined with:
2 pcs of Fitting B1
6 pcs of Fitting B2
4 pcs of Bolt and Nut B13

Technical information

Use and installation

Fitting B3

Delivered with bolt and nut.

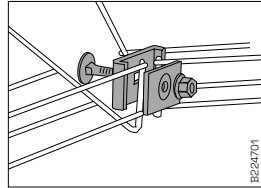
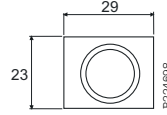

Horizontal bends are joined with Fitting B3.

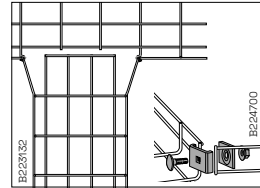

Four way and tees are joined with Fitting B3.

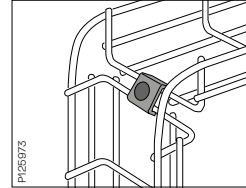

Vertical bends are joined with one or more Fitting B3, depending on mesh tray width.

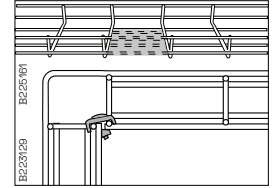

Mesh tray 53 is shaped to straight 90° angle by cutting out marked wires and joined with Fitting B3.

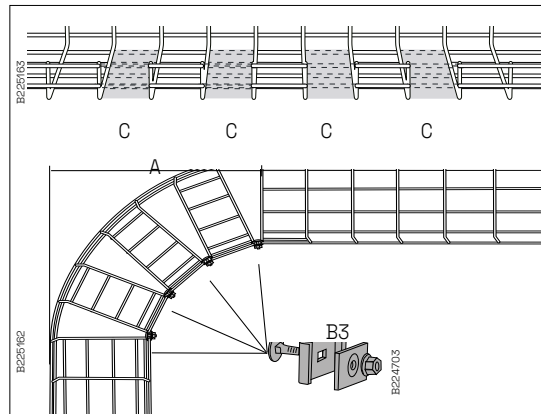

Mesh tray 120-622 is shaped to straight 90° angle by cutting out every other marked mesh tray section and joined with Fitting B3 according to table below.

Mesh tray	A mm	C No. of cut-out sections	Fitting B3 No.
120	300	2	2
220	550	4	4
320	820	6	6
422	1080	8	8
522	1320	10	10
622	1590	12	12

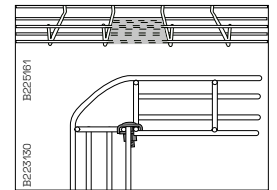

Mesh tray 53 is shaped to straight 90° angle by cutting out marked wires and joined with Fitting B3.

Technical information

Use and installation

Angled fitting B27

For tees and mountings to wall, ceiling and floor etc.

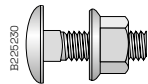
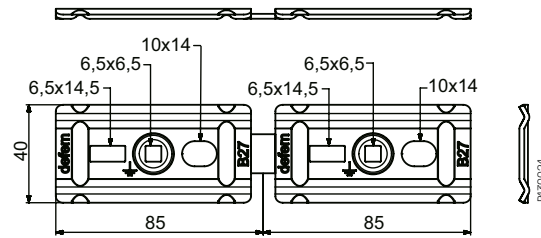

Bolt and nut B13

M6x25. Tensi-Lock and Flange Nut M6.

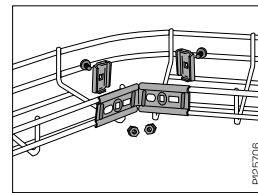
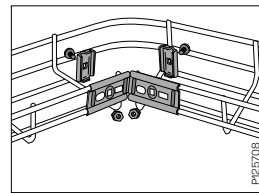
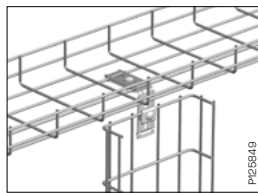

For vertical branching under mesh trays, all widths:
 1 pce of Angled fitting B27
 1 pce of Fitting B1
 1 pce of Fitting B2
 2 pcs of Bolt and Nut B13

To join the bend:
 1 pce of Angled fitting B27
 2 pcs of Fitting B2
 2 pcs of Bolt and Nut B13.

The bend can be adjusted by shaping the Angled fitting B27 to the required angle.

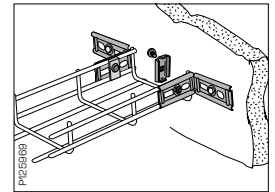
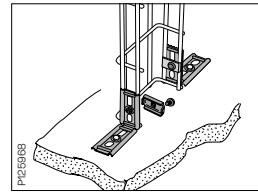
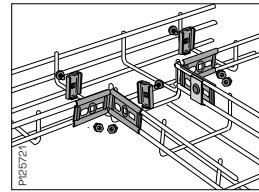
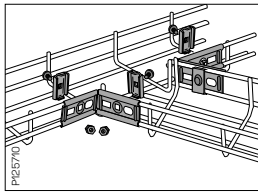

Tee with required angle is created with:
 2 pcs of Angled fitting B27
 4 pcs of Fitting B2
 4 pcs of Bolt and Nut B13.

90° tee is created with:
 2 pcs of Angled fitting B27
 4 pcs of Fitting B2
 4 pcs of Bolt and Nut B13.

Mounting to floor/ceiling is created with:
 2 pcs of Angled fitting B27
 2 pcs of Fitting B2
 2 pcs of Bolt and Nut B13.

Mounting to wall is created with:
 2 pcs of Angled fitting B27
 2 pcs of Fitting B2
 2 pcs of Bolt and Nut B13.

Joining set B52

Pre-assembled joining fitting (Fittings B1, B2, Bolt and Nut B13).
 Used for joining of the side sections.

Note! For joining of 320 mm trays and wider, extra Fittings B2 need to be mounted with Bolt and Nut B13 in the bottom of the trays.

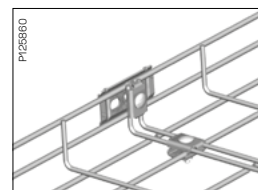
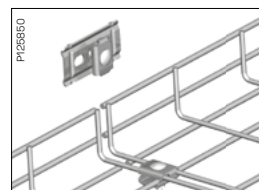
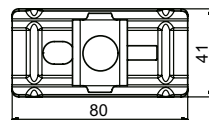
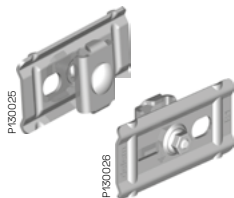

Mount Joining set B52 on the side section.

Tighten the bolt and the joining is finished.

Technical information

Use and installation

Bracket B4/B4 mini

For mounting of Mesh trays 53-622 onto wall and floor.

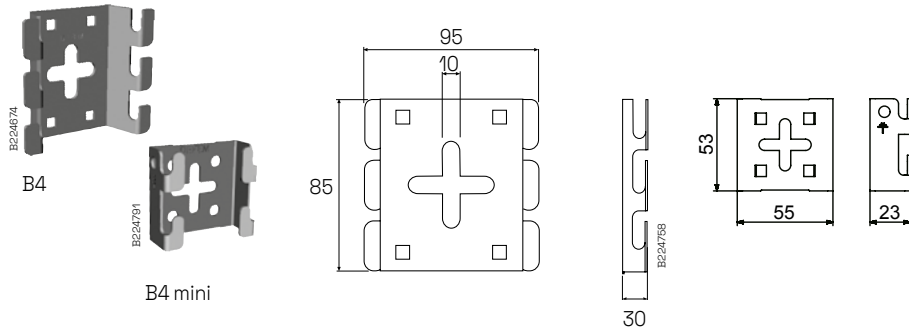

B4

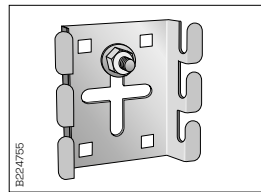

Mounted to wall/ceiling/floor with Expansion bolt in middle hole or screws in corner holes.

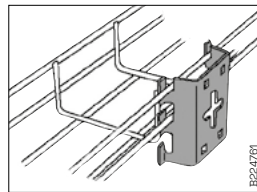

The side wires of the tray are easily hooked onto the grips of the bracket.

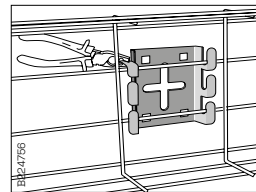

For increased stability, the B4 grips can be closed around the wires.

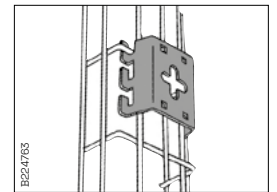

The mesh tray can also be mounted vertically.

B4 Mini

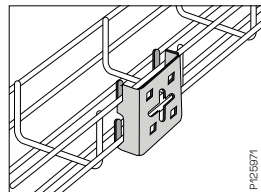

For horizontal mounting with bottom or side of tray onto the bracket grips.

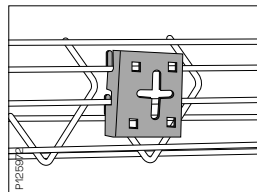

The mesh tray can also be mounted with 45° angle.

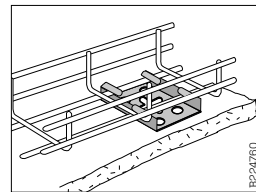

The Mesh tray can also be mounted to floor.

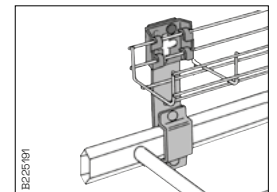

Mesh trays are mounted onto Combi Fitting B21 with Bracket B4 or B4 Mini.

Bracket B4 100/2, B4 100/4, B4 Mini 100

Brackets to be used for stable and secure mounting of mesh trays on walls and pendants. Intended for extended vertical or horizontal installation in hygienic areas where a distance is needed for cleaning purposes. Distance to the supporting surface 100 mm. Material: Stainless steel AISI316L.



B4 100/2 is used for Mesh tray 422-622 mm



B4 100/4 is used for Mesh tray 220-320 mm



B4 Mini 100 is used for Mesh tray 53-120 mm

Bracket B4 100/2, used for the mounting of mesh tray widths 422-622 mm, are to be installed in pairs in two lines for heavy mesh tray loadings.

Technical information

Use and installation - CLX³ Click suspension

CLX³ General information

Standards

CLX³ installation system is tested and following the classification according to the IEC 61537.

Usage of gloves

According to IEC 61537 it is always recommended to use protective gloves when handling and manipulating cable support systems.

Handling and storage

- Store in dry and covered places.
- Avoid moisture and pollutants.
- Do not remove the packing until installation.
- Take care when storing and handling so that the CLX³ components are well protected from damage.

CLX³ Pendant loading configurations

CLX³ pendant is primarily designed for installation of the CLX³ support system, but can also be used for T-bolt installation.

The system can be installed in different configurations:

- Click direction **(1)**: the cantilever and the ceiling plate are in the same direction
- T-bolt direction **(2)**: a cantilever is fixed with a T-bolt to the rail, in the opposite direction of the ceiling plate
- T installation **(3)**: combination of the first 2 installations
- Central suspension **(4)**: the pendant is completed by a central suspension bracket
- T and central suspension **(5)**.

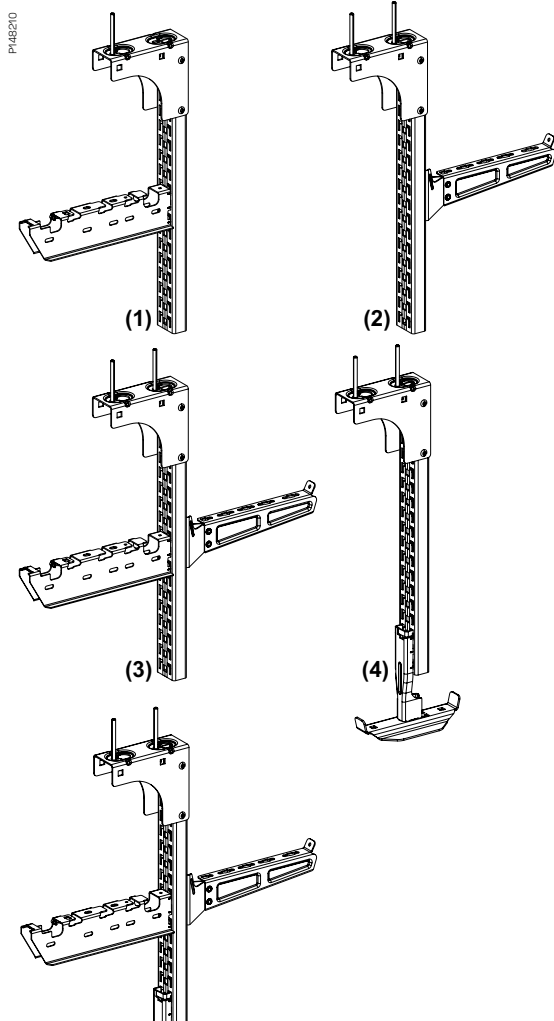

Fixation to the ceiling

Keyhole design

Keyhole design is facilitating easy mounting of the pendant to the ceiling by allowing the bolts to be pre-fixed before finally placing the pendant and tightening the bolts.

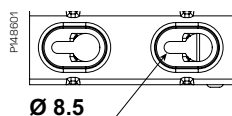

For concrete ceiling, use bolts type IMT38051.

For other bolts where bolthead is < 16 mm use washer u 16 mm.

One bolt fixation

For click direction installation of CLX³ Cantilever arm **(1)**, use a single bolt, in the outer hole position on the ceiling plate.

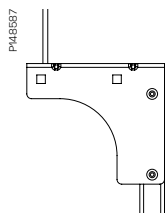

Two bolt fixation

For T-bolt suspension, central suspension, T installation and T and central suspension installation **(2)**, **(3)**, **(4)**, **(5)**, always fix the ceiling plate to the ceiling using 2 bolts.

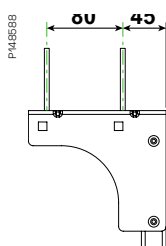

Use the angle adaptor when the ceiling is not horizontal to level out the suspended pendant.

Technical information

Use and installation - CLX³ Click suspension

CLX³ Pendant load calculation

To verify that the load applied to each pendant is within performance, it is necessary to calculate and consolidate the total **tensile load force** and the total **moment-force** on each pendant and for each cantilever and after that compare the calculated values with the defined loading limitations to ensure a safe installation.

Total tensile force Ft calculation method

This is calculated as the sum of all forces applied to the pendant from the weight of cables on the length material.

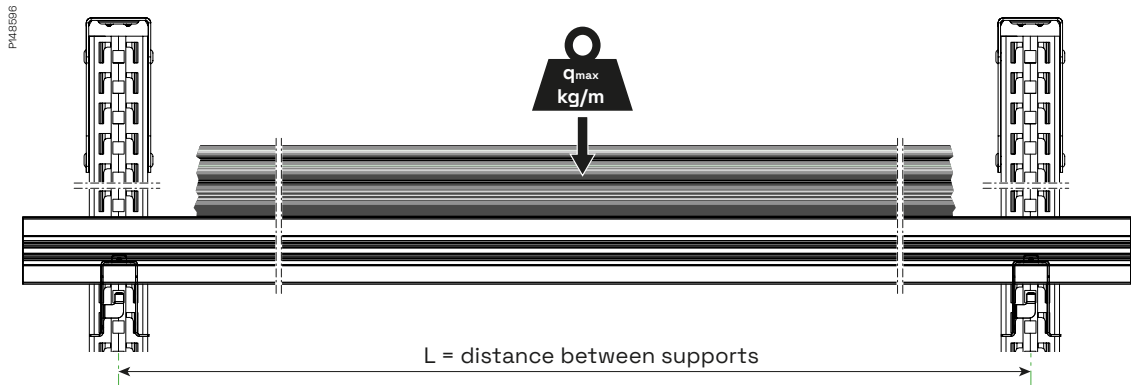

Ft (total load in N) = **L** (span or supports distance in meters) x **q_{max}** (load in kg/m) x 10.

In case of several layers are installed on the pendant then the sum of the Ft tensile load from all layers shall be calculated.

Total momentum force Mt calculation method

This is calculated as the sum of all the torsion forces applied to the pendant from the weight of cables on the length material and the offset distance created by the cantilever arm.

Mt (momentum in N.m) = **Ft** (N) x **d** (distance between axis center and point load in meters)

“d” depends of the position of the length material on the cantilever arm.

The distance **d** can be different depending on installation method. When the length material is installed on the full width of the cantilever, use **d1**. For length material that are installed at the outer end of the arm, use **d2**.

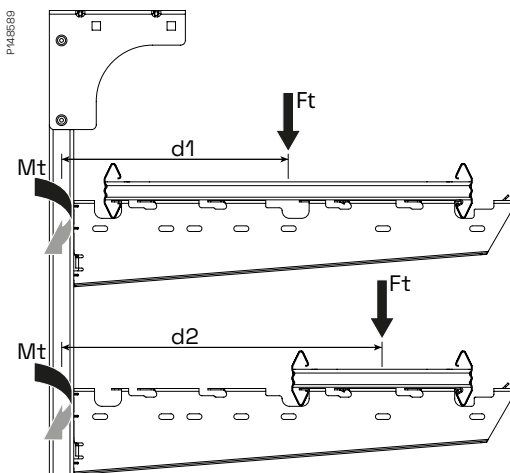

Model	PG	d1 (m)	d2 (m)
CLX ³ cantilever arm 150	CSU795646	0.110	NA
CLX ³ cantilever arm 200	CSU795647	0.140	
CLX ³ cantilever arm 300	CSU795648	0.190	0.340
CLX ³ cantilever arm 400	CSU795649	0.240	
CLX ³ cantilever arm 500	CSU795650	0.290	0.440
CLX ³ cantilever arm 600	CSU795651	0.340	

In case of several layers are installed on the pendant then the sum of the Mt momentum force from all layers shall be calculated.



Ensure that the installation is designed so that ΣMt and ΣFt are under the limits.

Technical information

Use and installation - CLX³ Click suspension

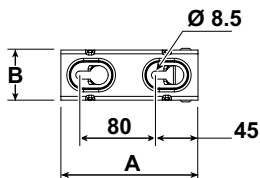
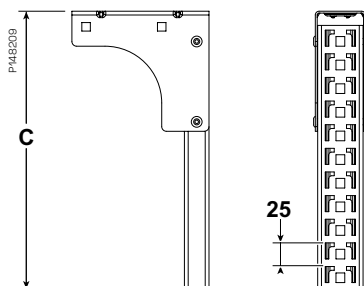
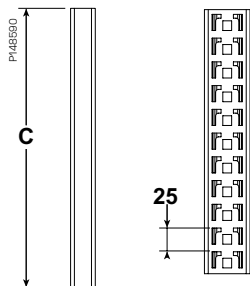
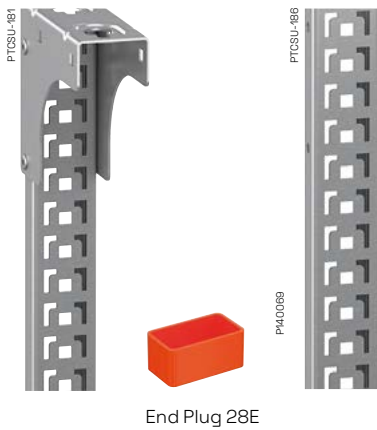

CLX³ Pendant 24/48

Vertical piece with a perforated pattern to be used for installation of CLX³ cantilever arms or CLX³ central suspension adapter. The open side of the rail can be used for installation of cantilever arms and brackets together with T-bolt. Can be joined to CLX³ Rail 24/48 with pendant joint 2FJ.

Model	PG	High (mm) A	Width (mm) B	Length (mm) C
CLX³ pendant				
CLX ³ pendant 24/48 300 mm PG	CSU795632	145	53	295
CLX ³ pendant 24/48 400 mm PG	CSU795633			395
CLX ³ pendant 24/48 500 mm PG	CSU795634			495
CLX ³ pendant 24/48 700 mm PG	CSU795635			695
CLX ³ pendant 24/48 1000 mm PG	CSU795636			995
CLX ³ pendant 24/48 1500 mm PG	CSU795638			1495
CLX³ rail				
CLX ³ rail 24/48 300 mm PG	CSU795640	26	48	280
CLX ³ rail 24/48 1000 mm PG	CSU795641			980
CLX ³ rail 24/48 3000 mm PG	CSU795637			2980

Pendants Safe Working Load (SWL)

SWL for bending moment of the pendant **Mt**.

Model	PG	Moment (N.m) Click side	Deflection (mm)
CLX ³ pendant 24/48 300 mm PG	CSU795632	235	2
CLX ³ pendant 24/48 400 mm PG	CSU795633		4
CLX ³ pendant 24/48 500 mm PG	CSU795634		7
CLX ³ pendant 24/48 700 mm PG	CSU795635		15
CLX ³ pendant 24/48 1000 mm PG	CSU795636		30
CLX ³ pendant 24/48 1500 mm PG	CSU795638	200	30

Tested according to IEC 61537 standard.

SWL bending moment for Adjustable ceiling plate **Mt**.

Model	PG	Moment (N.m) Click side
CLX ³ adjustable ceiling plate	CSU795639	235

SWL pendant tensile strength **Ft**.

Model	PG	Tensile load SWL (N) 1 bolt CLX ³	Tensile load SWL (N) 2 bolts CLX ³
CLX ³ pendant 24/48 300 mm PG	CSU795632	2000	5000
CLX ³ pendant 24/48 400 mm PG	CSU795633		
CLX ³ pendant 24/48 500 mm PG	CSU795634		
CLX ³ pendant 24/48 700 mm PG	CSU795635		
CLX ³ pendant 24/48 1000 mm PG	CSU795636		
CLX ³ pendant 24/48 1500 mm PG	CSU795638		

Technical information

Use and installation - CLX³ Click suspension

CLX³ Pendant limits, torque and deflection

In the diagram below it is possible to check if ΣMt is below the momentum limitation of the pendant (end of line). It is also possible to see the deflection on the pendant at max ΣMt and all values below.

Calculation example

For a cantilever size 600, full size ladder installation, 3 m span, load of 23 kg/m on a 1000 mm pendant.

1) ΣF : 3 m (span) x 23 kg/m (load) x 10 = 690 N will be the load for each pendant system.

2) ΣMt : 690 (N) x 0.34 (m) = 234 N.m.

ΣF = 690 N \leq 2000 N and ΣMt = 234 Nm \leq 235 N.m.

3) Drawing of the lines on the graph: for 234 N.m, the deflexion on the pendant is **30 mm**.

Torque / Deflection pendant

— 1500 — 1000 — 700 — 500 — 400 — 300 - - - - - Example

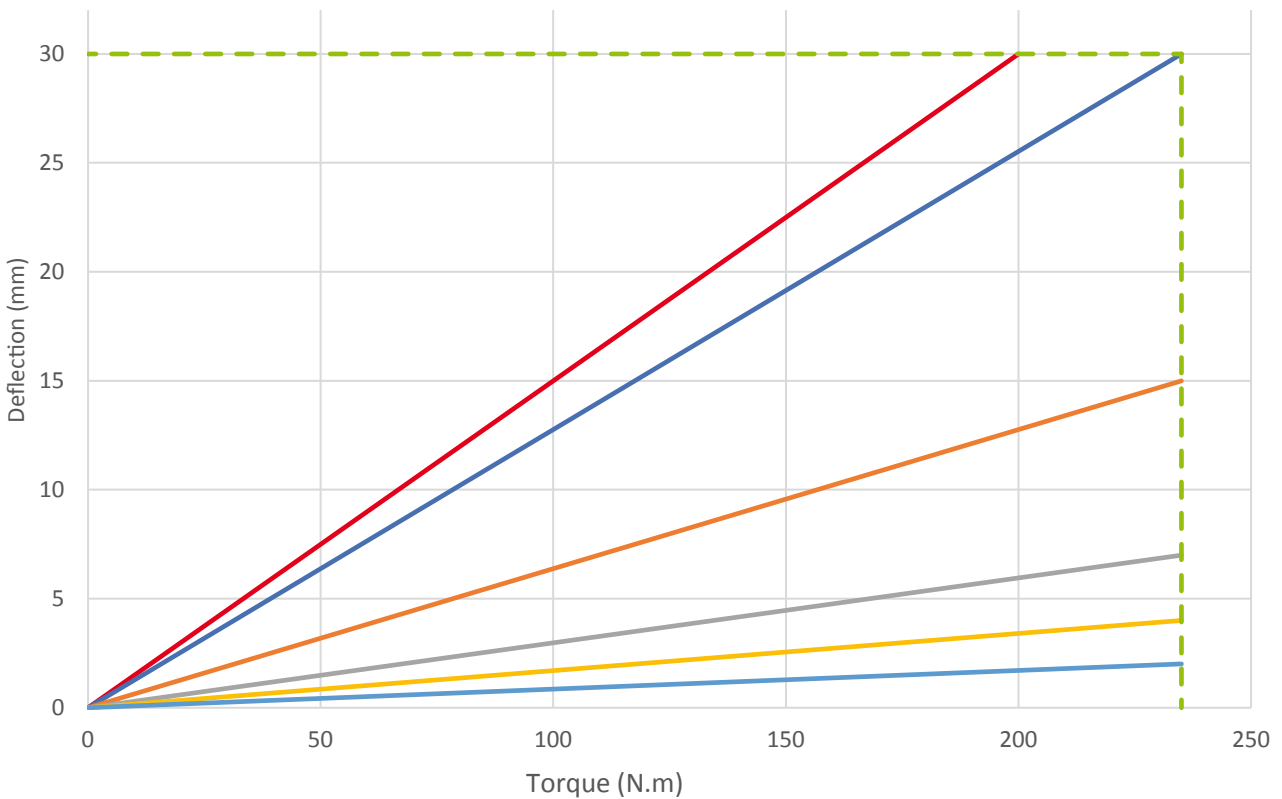

Technical information

Use and installation - CLX³ Click suspension

Distance between rails and offset

CLX³ rail have a pitch between the patterns of 25 mm.

The support distance between the pendants should be at least 1.5 m. If the length material can't be installed on the exact same level, the length material should be installed on the closest offset- pitch and never at more than 12.5 mm vertically from the previous pattern.

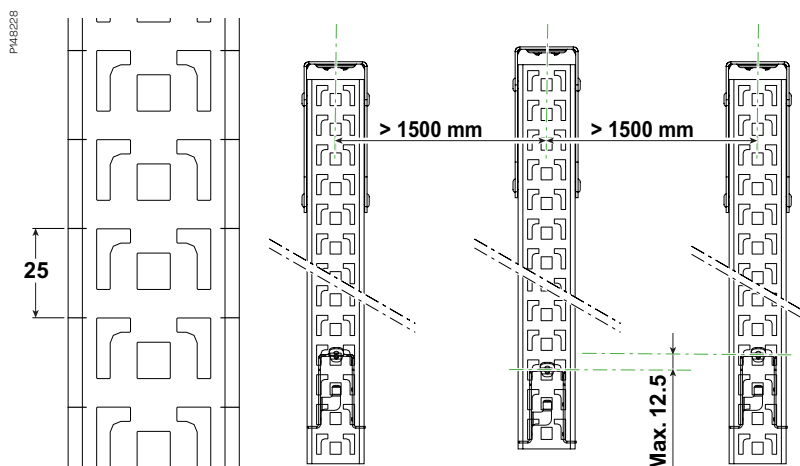

Cutting of the pendant or rail

Cutting of the rail or the pendant should be made at 8 mm under the last pattern needed, as the side marks are showing. This to assure that there is enough material below the bottom pattern to secure proper fixation of the cantilever arm.

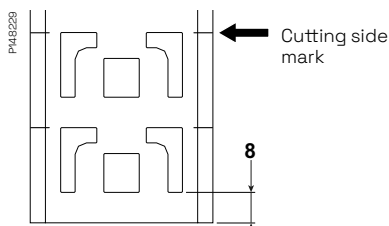

Installation of the rail joint

CLX³ rails can be joined together with pendant joint 2FJ.

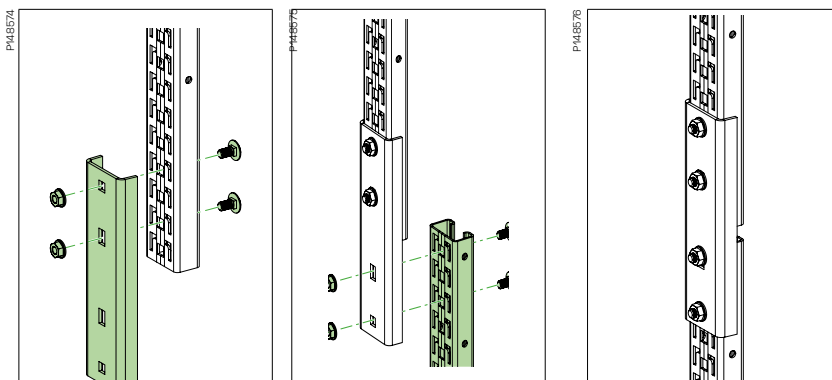

Place the joint on the rail in place, make sure the 2 top holes are in front of slots to install the included bolts and nuts.

Install the second rail as high as possible and install the other bolts and nuts.

Torque of the nuts **11 N.m.**

Note: extending the pendant with the rail joint will decrease the load capacity of the pendant. For SWL information when extending the pendants, contact Technical support.

Technical information

Use and installation - CLX³ Click suspension



Adjustable ceiling plate

Adjustable ceiling plate is used together with CLX³ pendant to allow for angle correction up to 25°. The adjustable ceiling plate is fixed to the CLX³ pendant with 4 screw set 22S to be ordered separately. The pendant can be fixed to the adjustable ceiling plate in both possible directions (1) and (2).

Model	PG	High (mm) A	Width (mm) B	Length (mm) C
CLX ³ adjustable ceiling plate PG	CSU795639	100	59	150

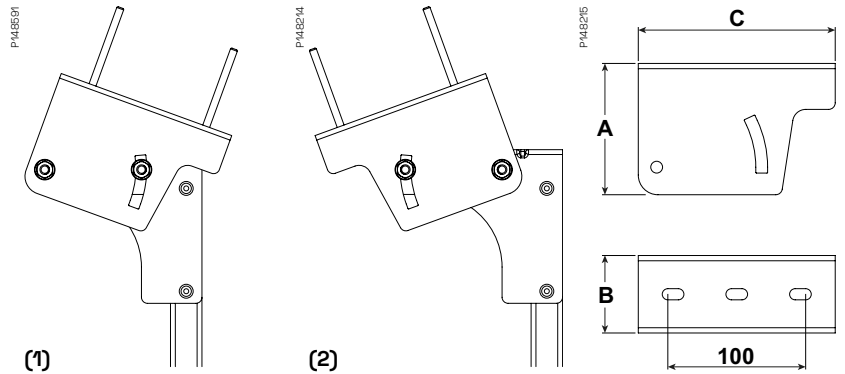

Installation of the adjustable ceiling plate

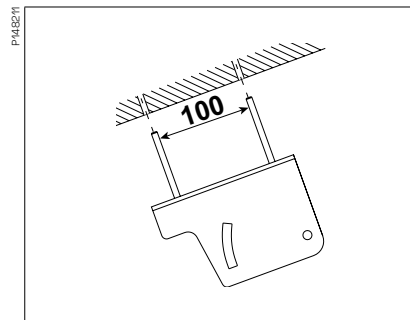

Fix the adjustable ceiling plate to the ceiling with 2 bolts. (c-c: 100 mm).

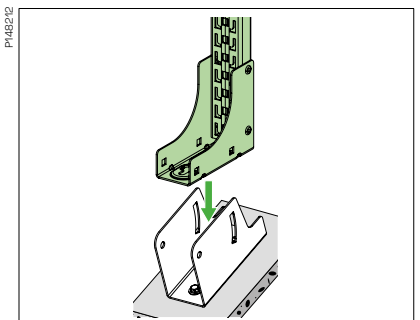

Insert the pendant into the adjustable ceiling plate.

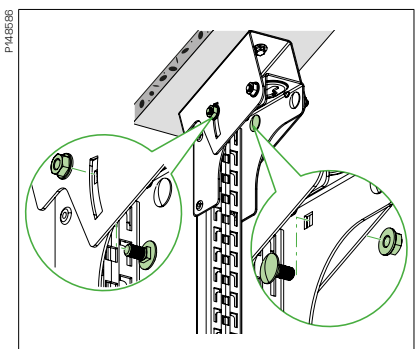
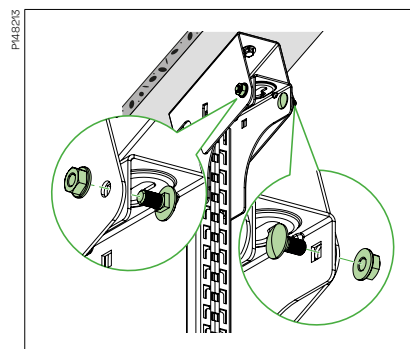

Fix the pendant to the adjustable ceiling plate with 4 bolt sets 22S and align the pendant to the vertical plane before tightening the bolts.
Recommended torque 20 N.m.

Technical information

Use and installation - CLX³ Click suspension

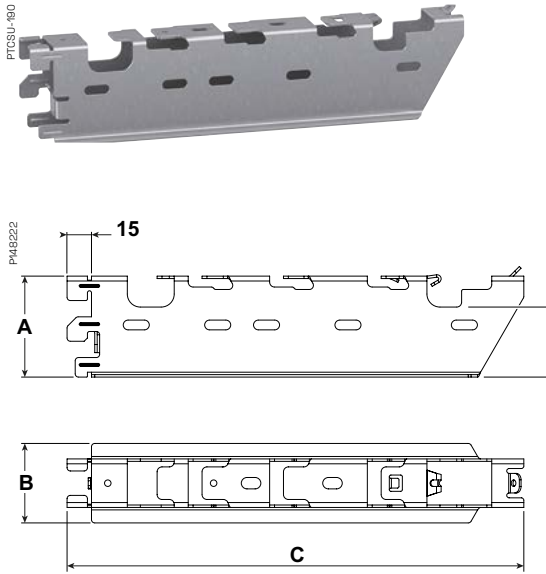

CLX³ Cantilever arm

The CLX³ cantilever arm is a screw-less cantilever that clicks into the pattern in the CLX³ pendant and rail. The cantilever arm is used to fix either the KHZSP ladder, the Defem mesh tray or the Stago height 60 trays. It can also be used for the Performa mesh trays together with fixation bolts.

Model	PG	High (mm) A	Width (mm) B	Length (mm) C	Height below ladder (mm) D
CLX ³ cantilever arm 150 PG	CSU795646	62	49	220	NA
CLX ³ cantilever arm 200 PG	CSU795647	62	49	280	43
CLX ³ cantilever arm 300 PG	CSU795648	62	49	380	43
CLX ³ cantilever arm 400 PG	CSU795649	92	49	480	73
CLX ³ cantilever arm 500 PG	CSU795650	92	49	580	73
CLX ³ cantilever arm 600 PG	CSU795651	92	49	680	73

Cantilever arm size compatibility

The click pattern on the cantilever arm is in some cases fitting more than one ladder width to make it possible to avoid pillars or obstacles on the wall. See the table and illustration below.

The table also clarifies which cantilever arm to use for each with of Defem mesh tray.

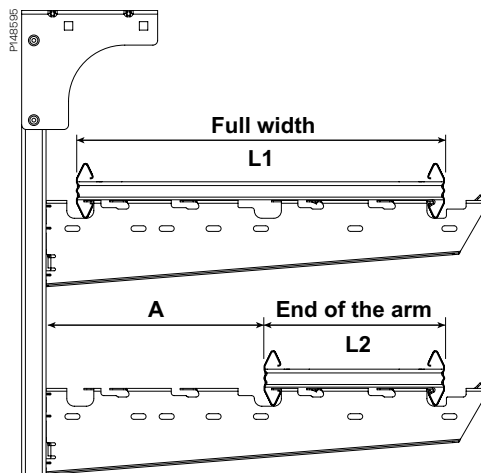

Model	PG	Compatible ladder (offset)		Space to the offset ladder (mm) A	Defem size compatibility
		L1	L2		
CLX ³ cantilever arm 150 PG	CSU795646	NA	NA	NA	120
CLX ³ cantilever arm 200 PG	CSU795647	200	NA	NA	220
CLX ³ cantilever arm 300 PG	CSU795648	300	NA	NA	320
CLX ³ cantilever arm 400 PG	CSU795649	400	200	232	420
CLX ³ cantilever arm 500 PG	CSU795650	500	200	332	520
CLX ³ cantilever arm 600 PG	CSU795651	600	300	332	620

Cantilever arms Safe Working Load (SWL)

SWL of the cantilever bracket

Model	PG	Safety working load as wall bracket (full width) (N)	Safety working load as wall bracket (end of the arm) (N)
CLX ³ cantilever arm 150 PG	CSU795646	1800	NA
CLX ³ cantilever arm 200 PG	CSU795647	1800	
CLX ³ cantilever arm 300 PG	CSU795648	1250	1000
CLX ³ cantilever arm 400 PG	CSU795649	1250	
CLX ³ cantilever arm 500 PG	CSU795650	1250	750
CLX ³ cantilever arm 600 PG	CSU795651	1000	700

Tested according to IEC 61537 standard.

Technical information

Use and installation - CLX³ Click suspension

Installation of cantilever arms

CLX³ cantilever arms are clicked to the CLX³ pendants and rails. Make sure to select a pattern allowing all hooks to grip and the full cantilever back to be supported by the rail. The horizontal wing must touch the rail.

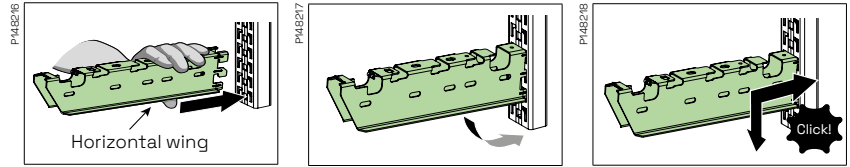

Hold the cantilever close to the hooks and insert the hooks in the rail.

Press the cantilever until the horizontal/top surface touch the rail.

Press against the rail and pull it down until the locking lip go inside the slot in the rail.

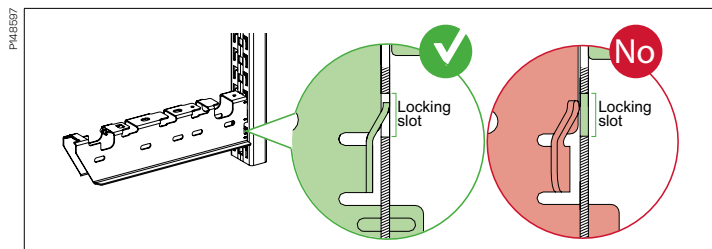

Visually check that the cantilever arm is properly positioned and the locking lip is positioned inside of the slot of the CLX³ rail.



Apply caution with unintended upward movements as it can cause the cantilever arm to unlock and therefore be released from the rail.

Uninstallation of CLX³ cantilever arm using screwdriver

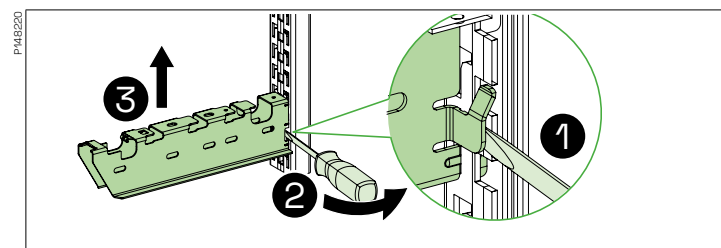

1 Fit the head of the screwdriver between the rail and the locking lip of the cantilever.

Use the screwdriver as a lever to 2 push the lip out of the rail.

Deform the lip as little as possible and 3 push the cantilever up to be able to unhook the cantilever arm.

Before reinstalling a cantilever that has been removed after installation, make sure the lip is locking properly. If not, correct the lip to the initial position.

Technical information

Use and installation - CLX³ Click suspension

Installation of Defem mesh trays on cantilever arms

CLX³ cantilever arms are designed to fix Defem mesh trays, height 60 and 110, without need of tools or bolts.

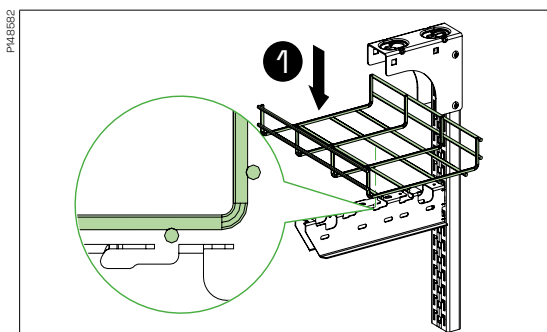

1 Insert the longitudinal wires in the slots.

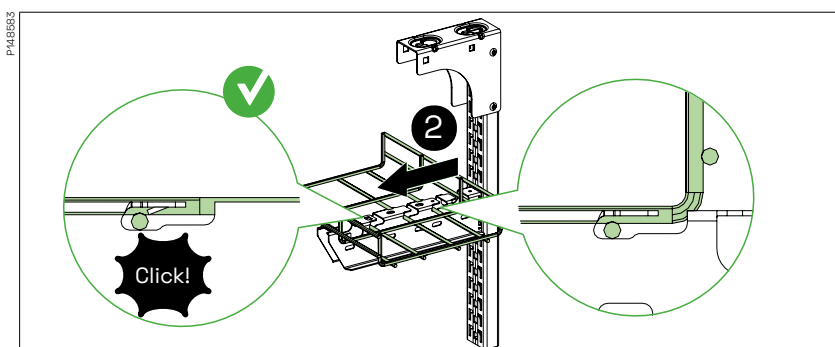

2 Pull the mesh tray horizontally towards the tip of the cantilever arm until the mesh tray wire passes the locking lip and clicks into position.

Process in the opposite order to dismount the mesh tray.

Technical information

Use and installation - CLX³ Click suspension

Installation of Performa mesh trays on cantilever arms

Performa mesh trays can be fixed to the CLX³ cantilever arms with bolted couplers. The number of bolted couplers needed depends on the width of the tray.

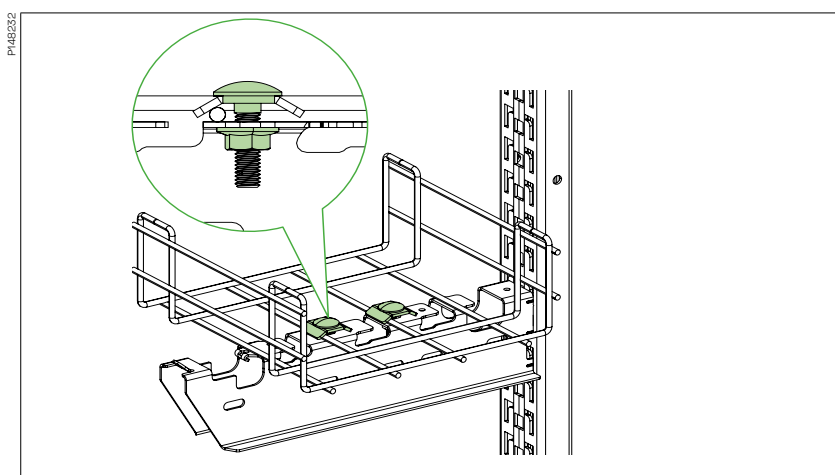
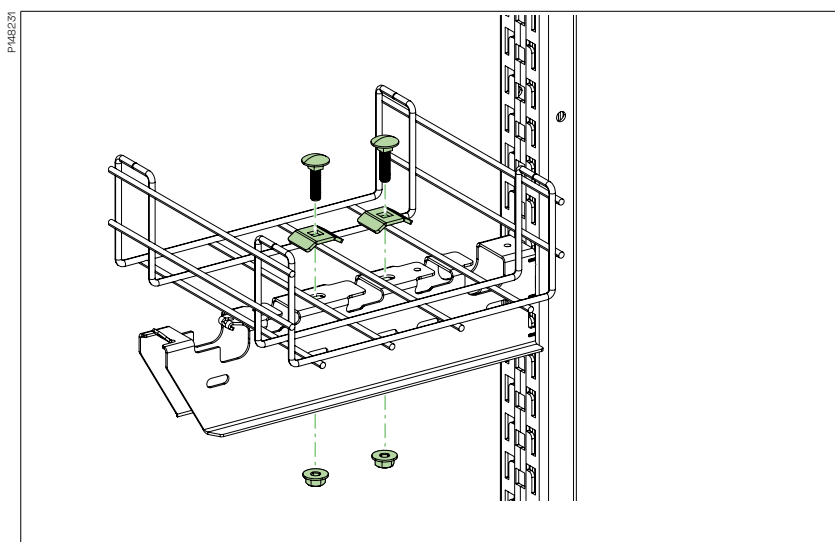
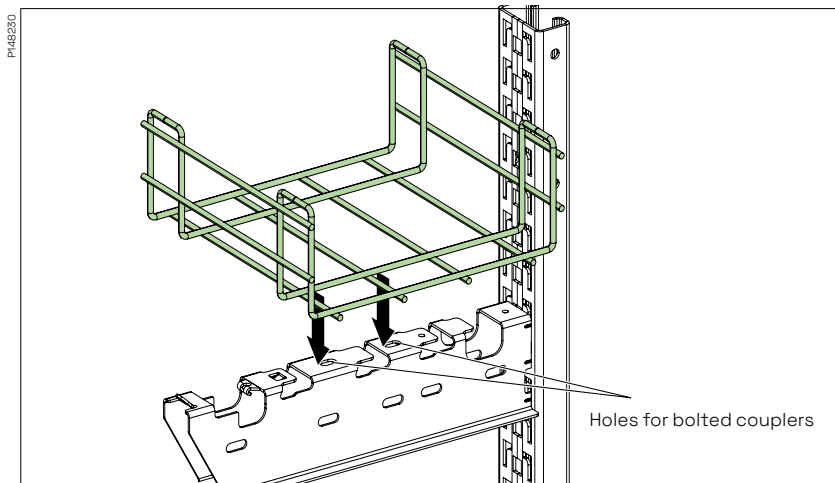

Place the Performa mesh tray on the top surface of the cantilever arm, as close as possible to the rail and by leaving at least 20 mm. Insert the bolts of the couplers on the oblong holes on the top. Tight the nuts under the cantilever arm (**12 N.m**).

Technical information

Use and installation - CLX³ Click suspension

CLX³ Central suspension adapter

The CLX³ central suspension adapter is clicked together with the central suspension brackets to create a central suspension piece that can be clicked to the rail or pendant.

Model	PG	High (mm) A	Width (mm) B	Length (mm) C
CLX ³ Central suspension adapter PG	CSU795700	166	31	39

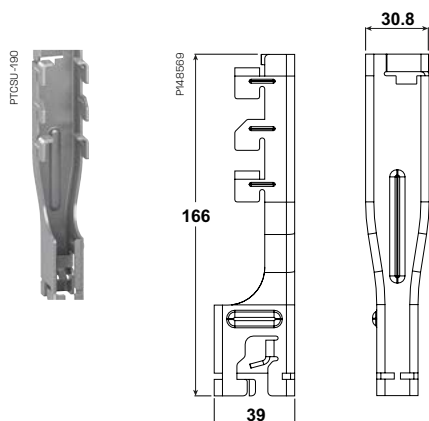

Installation of the Wall bracket

The Wall bracket is made to directly fix a Cantilever arm to a wall, without using a full-size rail. The Wall bracket doesn't reduce the SWL of the cantilever arm and the distance between the back of the cantilever and the wall is the same as with a rail.

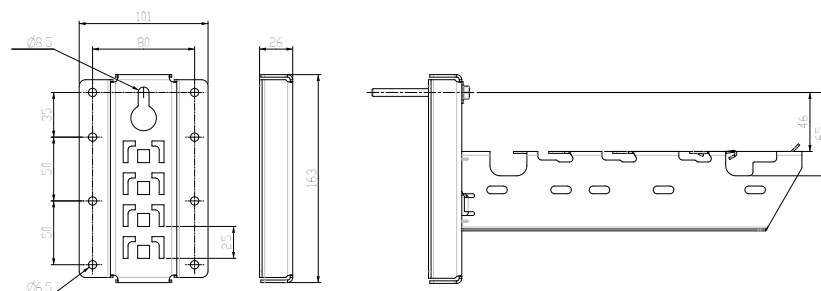

The wall bracket can be fixed in two different ways: With the keyhole (A) or with the lateral holes (B).

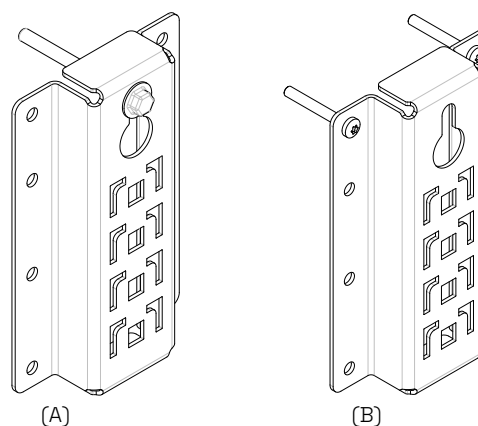

The keyhole design allows to pre-fix the bolt in the wall, before installing the bracket.

For concrete wall, use bolts IMT38051.

For non-concrete wall, M8 bolts with washer >Ø16 should be used.

For the lateral holes, the bracket should always be fixed with at least the two top Ø6mm holes (same height as the keyhole). The left and right bolts should be horizontally separated by 80mm (axis to axis).

Technical information

Use and installation - CLX³ Click suspension

Installation of adaptor to central suspension brackets

The CLX³ central suspension bracket is installed without tools by clicking it to the central suspension. The method is the same for Central suspension bracket ladder -mesh or -tray. In the illustration below, the CSB for ladder is used.

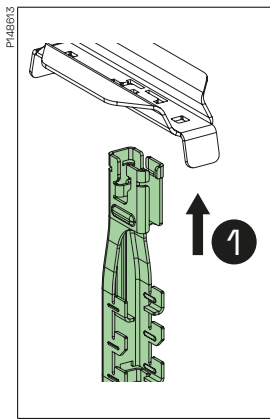
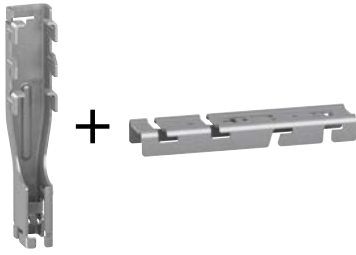

1 Insert the adaptor in the pattern on the central suspension bracket.

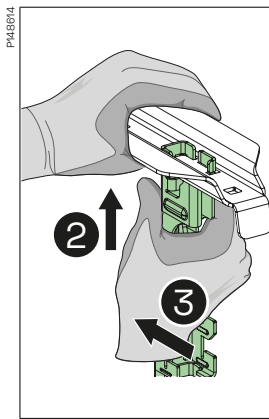

2 Press the pieces together and **3** slide the adaptor until the click lip of the adaptor pass over the locking lip of the central suspension bracket with a **4** click.

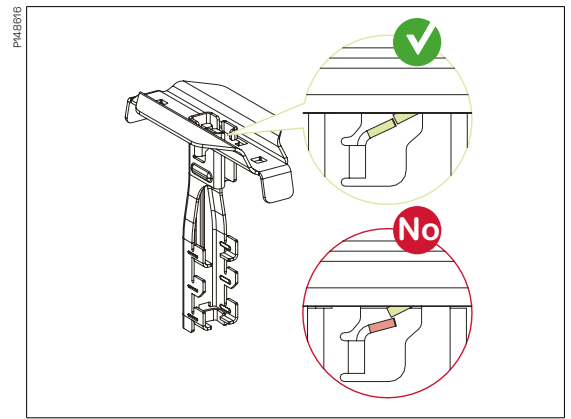
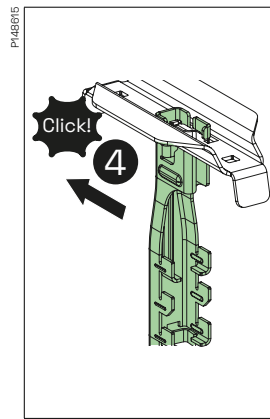

Visually check and secure that the adaptor is properly positioned, and the click lip has overpassed the locking lip.

Installation of central suspension adaptors to the CLX³ rail

The CLX³ central suspension adaptors is installed to the rail without tools, by clicking. To ensure proper installation a hooks must be inserted in the rail:

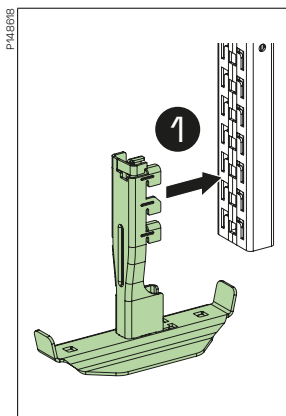

1 Push the central suspension piece until the hooks are fully inserted in the pattern and the surface touches the rail.

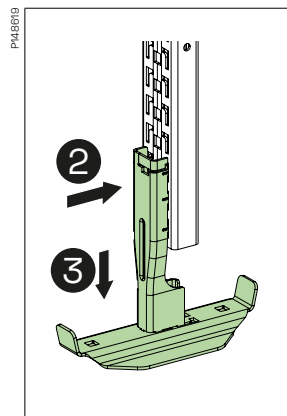

2 Press towards the rail and **3** pull down until the click lip.

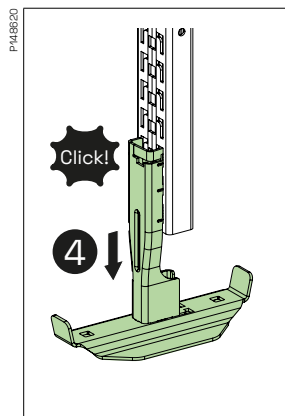

4 Pass inside the slot in the rail.

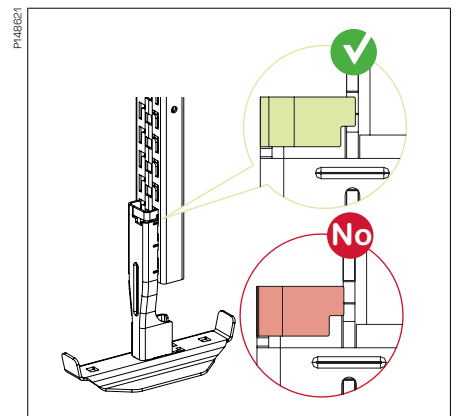

Visually check and secure that the adaptor is properly positioned, and the click lip is properly positioned inside of the slot of the CLX³ rail.



Apply caution with unintended upward movements as it can cause the adaptor to unlock and therefore be released from the rail

Technical information

Use and installation - CLX³ Click suspension

Uninstallation of adapter from the CLX³ rail

CLX³ central suspension adapters can be removed, by using a flat screwdriver.

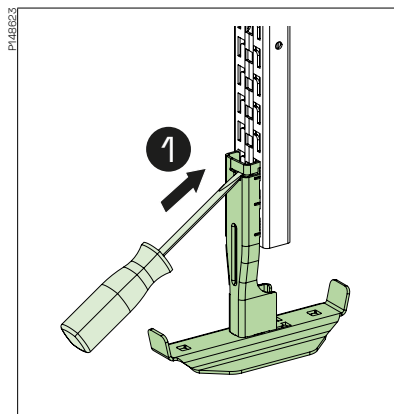

1 Fit the screwdriver's head in the slot of the adaptor.

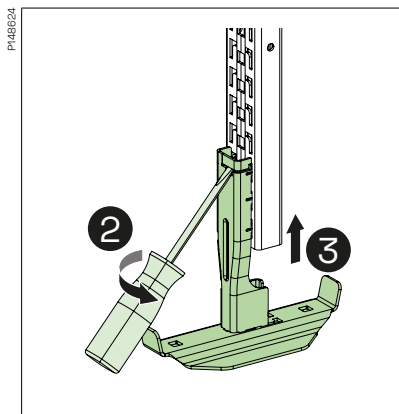

Use the screwdriver as a lever to 2 gently release the click lip from the rail. Then 3 push the adaptor up to release the L hooks from the rail.

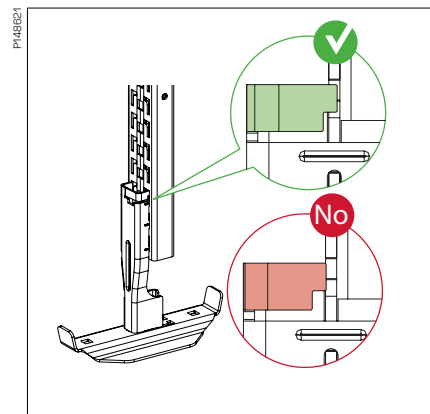

If the adapter needs to be reinstalled, correct the click lip to the initial position and make sure the click lip is locking properly.

Uninstallation of adaptor from central suspension brackets

CLX³ central suspension brackets can be removed, by using a flat screwdriver.

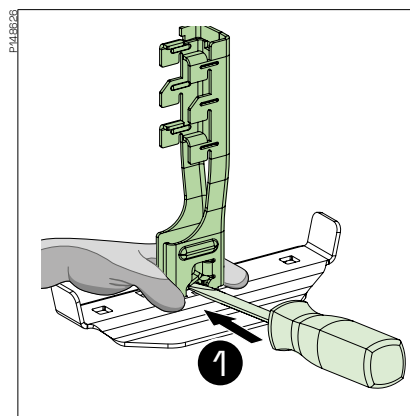

1 Hold the bracket, fit the screwdriver's head between the adaptor lip and the bracket.

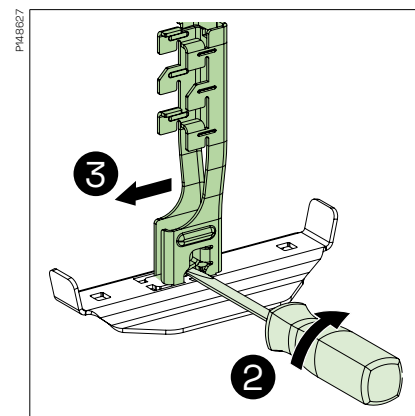

2 Twist the screwdriver to use it as a lever on the click lip until it passes over the bracket's locking lip and 3 pull the adaptor sideways to release it.

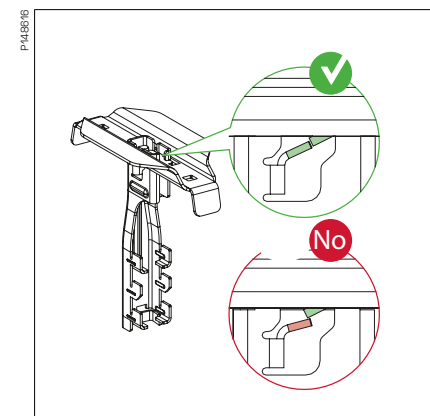

When the bracket needs to be reinstalled, correct the click lip to the initial position and make sure the click lip is locking properly.

Technical information

Use and installation - CLX³ Click suspension

CLX³ Defem mesh tray central suspension bracket

Bracket to be used for central suspension of Defem mesh trays. The bracket shall be used for mounting Defem mesh trays on vertical pieces.

PTCSU-207



PTCSU-208



Model	PG	High mm A	Width mm B	Length mm C
CLX ³ Defem central suspension bracket 120-220 PG	CSU795665	163	31	84
CLX ³ Defem central suspension bracket 320 PG	CSU795666	25	50	206
CLX ³ Defem central suspension bracket 422 PG	CSU795668	25	50	397
CLX ³ Defem central suspension bracket 522-622 PG	CSU795667	25	50	497

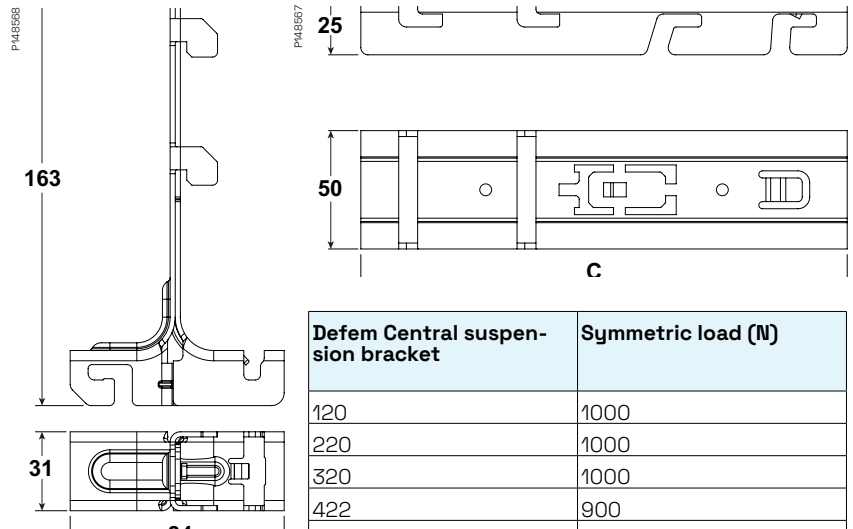

Defem Central suspension bracket	Symmetric load (N)
120	1000
220	1000
320	1000
422	900
522-622	700

Technical information

Use and installation - CLX³ Click suspension

Installation of central suspension bracket for Defem mesh tray 120/220

CLX³ central suspension bracket for Defem 120/220 width don't require tools to be installed.

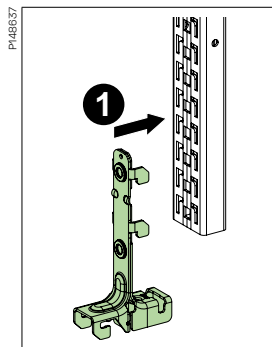

1 Press the bracket until the hooks are fully inserted in the pattern and the surface touches the rail.

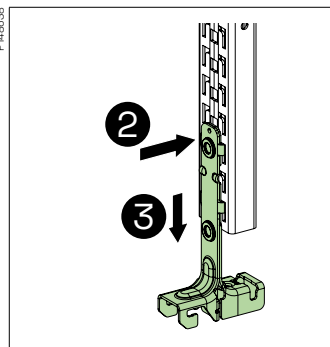

2 Press against the top of the bracket towards the rail and **3** pull it down until the locking lip go inside the slot in the rail.

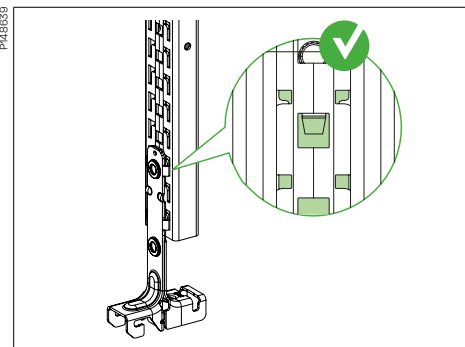

Visually check and secure that the cantilever arm is properly positioned and the locking lip is positioned inside of the slot in the CLX³ rail.

CLX³ central suspension bracket for Defem 120/220 can also be installed by using a screwdriver.

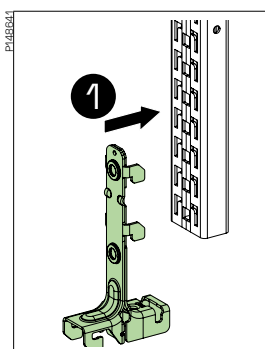

1 Press the bracket until the hooks are fully inserted in the pattern and the surface touches the rail.

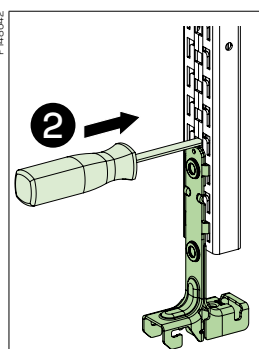

Hold the bracket and **2** insert the screwdriver in the slot just above the bracket.

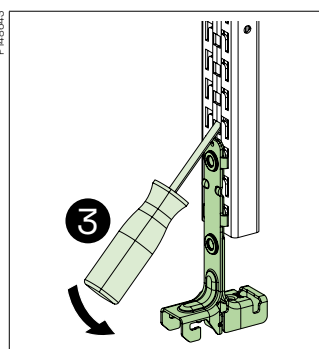

3 Use the screwdriver as a lever to pull down the bracket until the locking lip go inside the slot in the rail.

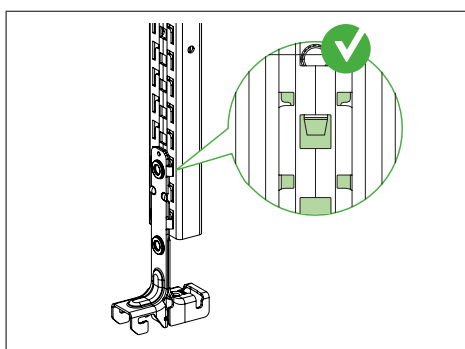

Visually check and secure that the bracket is properly positioned, and the click lip is positioned inside the slot in the CLX³ rail.

Uninstallation of central suspension brackets for Defem 120/220 from the CLX³ rail

CLX³ central suspension brackets for Defem 120/220 can be removed, by using a flat screwdriver.

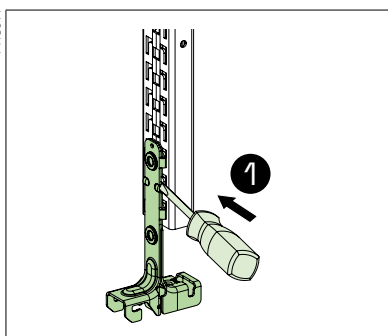

1 Insert the head of the screwdriver in the bump in the bracket and with the head simultaneously gripping in one of the slots in the rail.

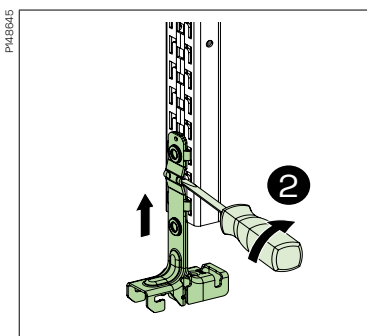

2 Twist the screwdriver to push the bracket upwards until the bracket is released.

Technical information

Use and installation - CLX³ Click suspension

Installation of Defem mesh tray on CLX³ Defem brackets 120/220

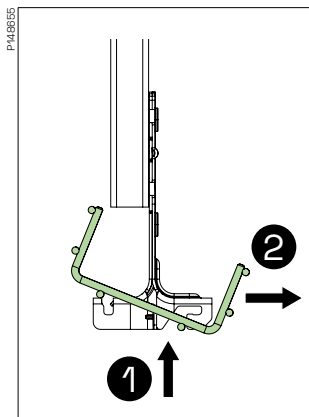

1 Insert the longitudinal wire in the down slot. **2** lift and push.

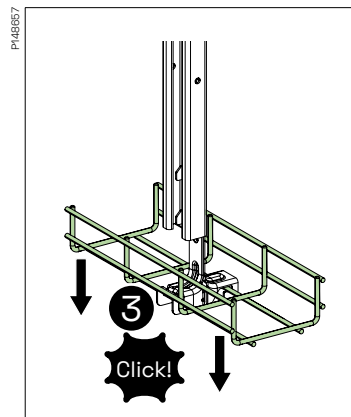
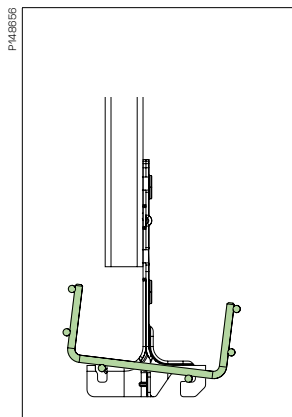

3 Push down the other wire until it has overpassed the locking lip.

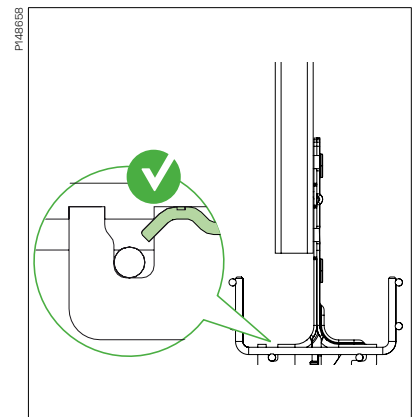

Visually check that the wire is properly positioned, and the wire has passed the locking lip.

Uninstallation of Defem mesh tray from CLX³ Defem central suspension bracket 120/220

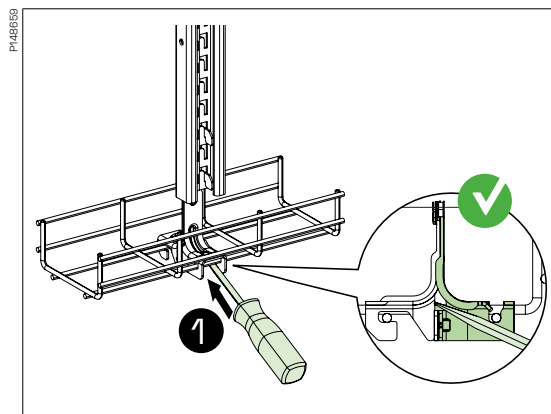

1 Insert the head of the screwdriver above the reinforcement of the bracket and under the mesh tray as showed on the picture.

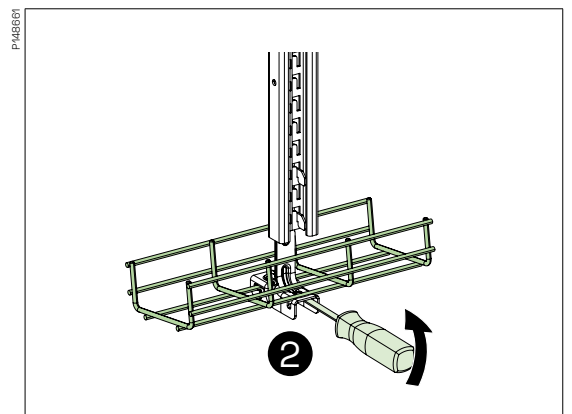

Hold the bracket and **2** use the screwdriver as a lever until the mesh tray overpass the locking lip.

Technical information

Use and installation - CLX³ Click suspension

Installation of Defem mesh tray on CLX³ central suspension bracket

CLX³ brackets are made to fix Defem trays without tool.

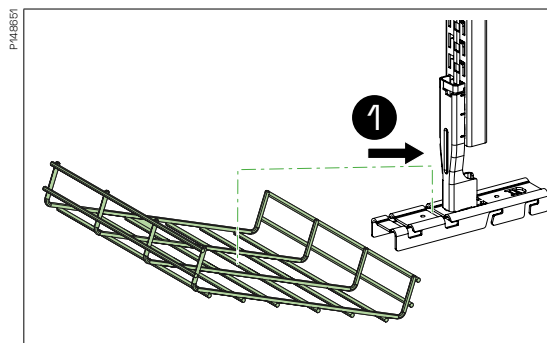
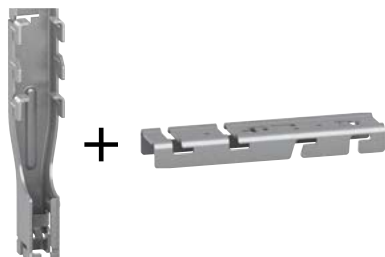

1 Slide the middle of the mesh tray on the upper slot side of the bracket and insert the longitudinal wire on the most center top slot.

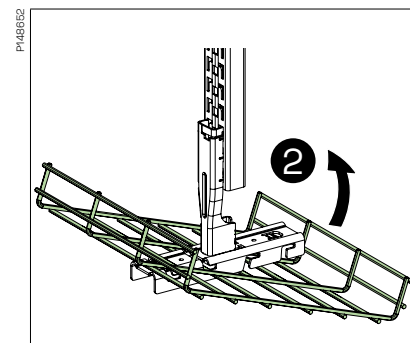

2 Rotate the tray until all the slots are filled.

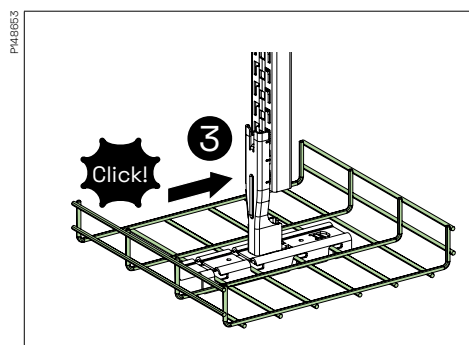

3 Push the tray to lock it in the bracket.

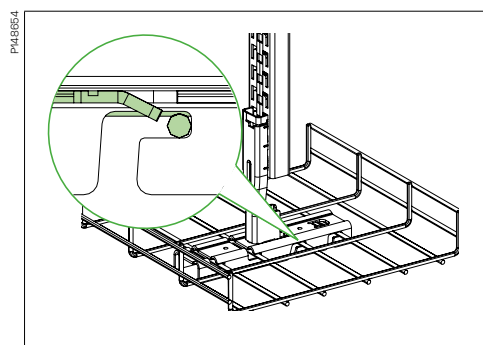

Visually check that the wire is properly positioned and the wire has passed the locking lip.

Technical information

Use and installation

Cantilever arm 50i

Cantilever arm to be used for lighter mountings on walls, vertical piecwes or pendant/fixing rails.

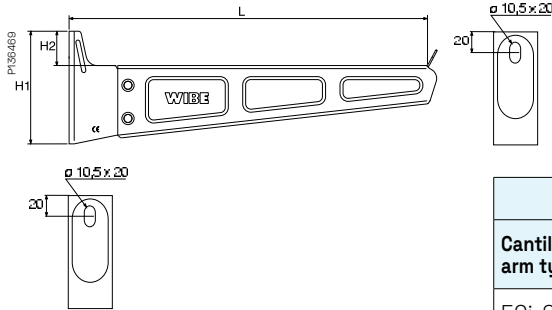

Cantilever arm type	Size		
	L mm	H1 mm	H2 mm
50i-200	250	85	28,5
50i-300	350	110	33,5
50i-400	450	115	31,0
50i-500	550	150	31,0
50i-600	650	150	31,0

Widths = 100

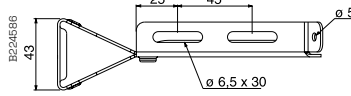

Widths = 200

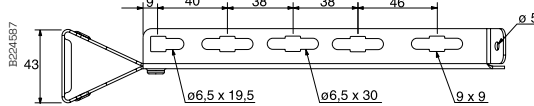

Widths = 300

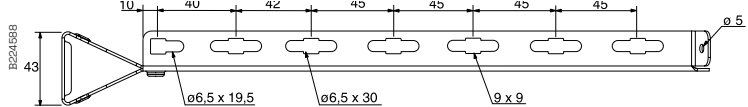

Widths = 400

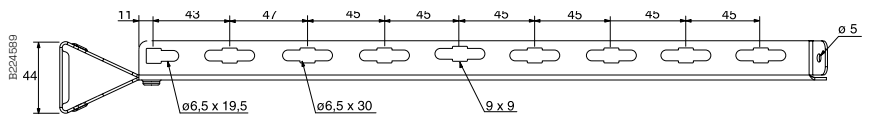

Widths = 500

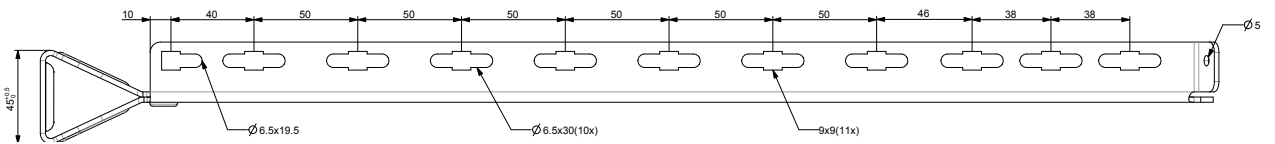

Widths = 600

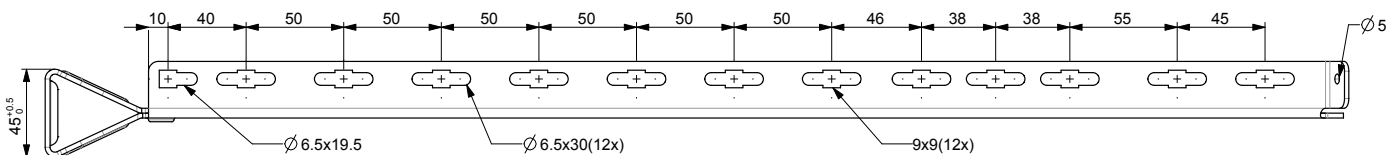

Technical information

Use and installation

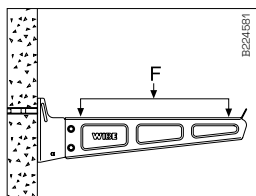

Installation of cantilever arm mounted to wall using Expansion bolt M8. Breaking load - See table below.

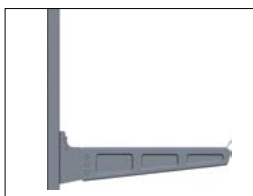

Mounting Cantilever arm 50i on pendant 2F/2FB with t-bolt.



Double cantilever arm 50i on pendant 2F/2FB with Screw set 20S

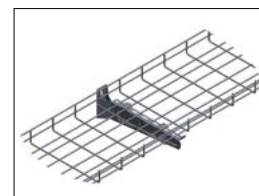

Mesh Tray mounted on Ca50i with 2 pcs of fitting B2 and 2 pcs of Nut B13 on longitudinal wire.

Safe Working Load (SWL) - Mounted on wall	
Type of cantilever arm	kg
50i-100	130
50i-200	120
50i-300	120
50i-400	170
50i-500	170
50i-600	170

Technical information

Use and installation

Pendant/Fixing rail 24/48

Pendant/Fixing rail for mounting of support brackets, cantilever arms, etc.

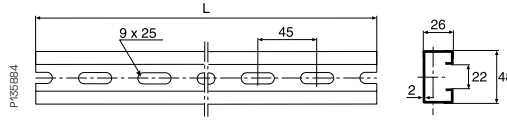

Type	L mm
Pendant/Fix. rail 24/48	2970

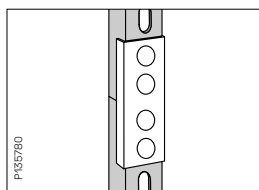

Vertical piece 2F may be joined using Pendant/Fixing rail 24/48 and Pendant joint 2FJ to achieve the required length.

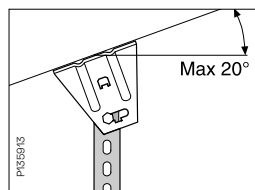

Ceiling bracket 5 and 1 Screw set 22S together provide a vertical piece that can be mounted with up to 20° slope. Only for mounting supportbrackets.

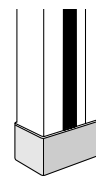

High visibility end plug for enhanced safety and provide protection against personal injury.

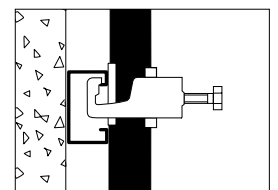

Cables are mounted on a Pendant/Fixing rail 24/48 using cable clamps of type A.

Pendant joint 2FJ

Pendant joint to be used for joining pendant/fixing rails and vertical pieces.

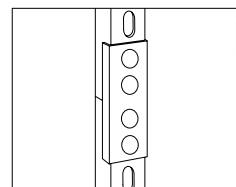
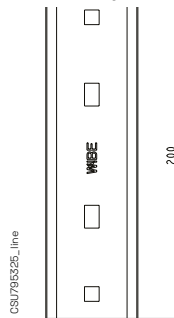

Pendant joint 2FJ, used for joining of vertical piece 2F.

Pendant bar 1

Pendant bar to be installed in order to reduce the deflection of heavily loaded vertical pieces. Installed with T-bolt and Expansion bolt.

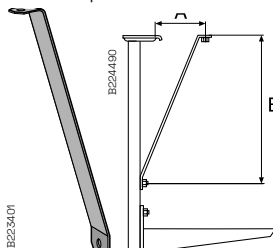

Pendant bar 1/500 Hdg

Type	A mm ¹	A mm	B mm
1/500	40	130	500

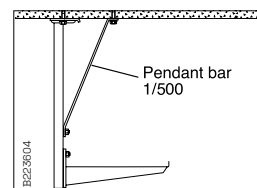

To reduce deflection of Vertical piece 2F at heavy loads on Cantilever arm 50 the Pendant bar 1 can be used. Install with T-bolt and Expansion bolt.

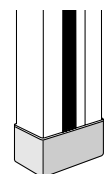

High visibility end plug for enhanced safety and provide protection against personal injury.

Technical information

Use and installation

Vertical piece 2

Vertical piece to be used for installation of Support bracket 3, symmetrical loading. Not suitable for cable ladders KHZV and KHZPV. Can be joined to Pendant/fixing rail 24/34 with Pendant joint 2J.

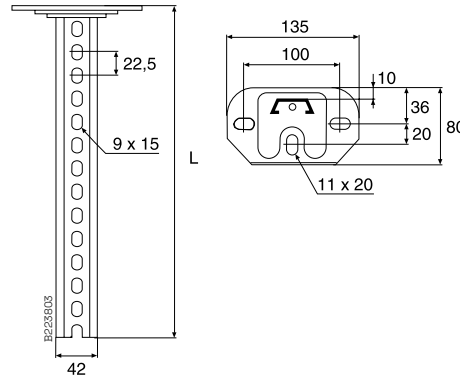
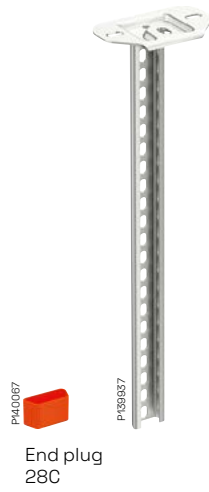

Type	L mm
Vertical piece 2/300	279
Vertical piece 2/400	392
Vertical piece 2/500	504
Vertical piece 2/700	729
Vertical piece 2/1000	1022

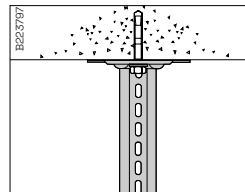

Mount Vertical piece 2 on a Fixing rail 24/26x53 using an Expansion bolt or a concrete screw.

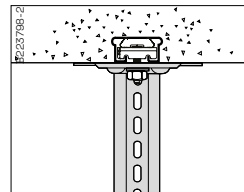

Mount Vertical piece 2 on a Fixing rail 24/26x53 for casting-in using T-bolt 26U.

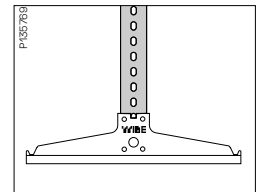

On Vertical piece 2, mount Support bracket 3 using Screw set 22S.

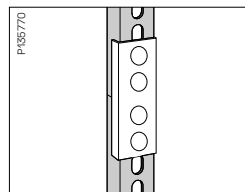

Vertical piece 2 can be joined to achieve the required length using Pendant/Fixing rail 24/34 and Pendant joint 2J.

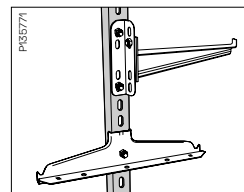

Cantilever arm 50 can, using End bracket HT-11, be mounted at 90° to the pendant/fixing rail. Only for lightweight mounting, such as data cables.

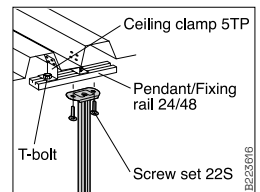

In ceilings with trapezoidal profile sheeting, mount Vertical piece 2 as shown above.

Breaking load

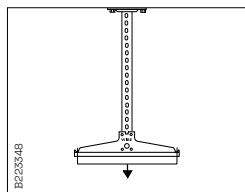

Breaking load for Vertical piece 2 with a symmetrical loading = 1400 kg (14 kN). See also breaking load for support bracket 3.

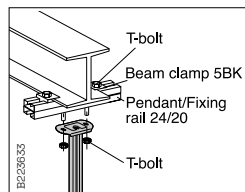

On beams in ceilings. When the beam flange thickness does not exceed 13 mm, use Beam clamp 5BK-10 and T-bolt 26U/40. For flange thicknesses not exceeding 30 mm use Beam clamp 5BK-30 and T-bolt 26U/50.

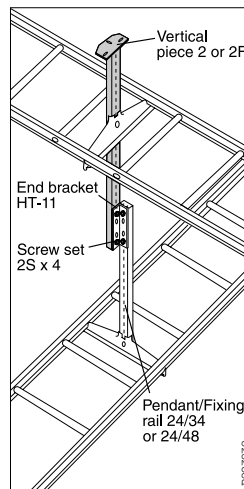

End bracket HT-11 permits the mounting of crossing cable ladders at different levels on the same pendant/fixing rail.

Technical information

Use and installation

Vertical piece 2F

Vertical piece to be used for installation of Support bracket 3 or Cantilever arm 50 /50i. Can be joined to Pendant/fixing rail 24/48 with Pendant joint 2FJ. Can be mounted from the ceiling or on the floor. Can also be installed as a cantilever arm on a wall.

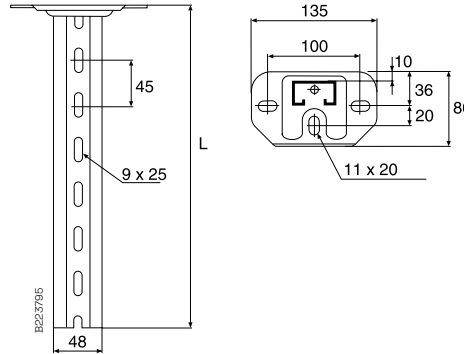

Type	L mm
Vertical piece 2F/280	280
Vertical piece 2F/505	505
Vertical piece 2F/1000	1000

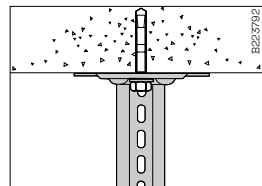

Mount Vertical piece 2F using Expansion bolt alt. Concrete screw.

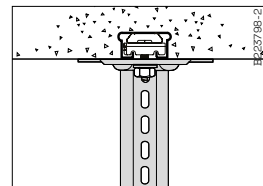

On Fixing rail forcastin-, mount Vertical piece 2F using T-bolt.

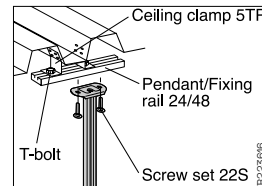

In ceilings with trapezoidal sheeting, mount Vertical piece 2F as shown above.

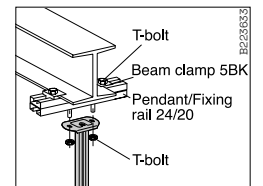

On beams in ceilings, mount Vertical piece 2F as shown in the figure above. When the beam flange thickness does not exceed 13 mm, use Beam clamp 5BK-10 and T-bolt 26U/40. For flange thicknesses not exceeding 30 mm use Beam clamp 5BK-30 and T-bolt 26U/50.

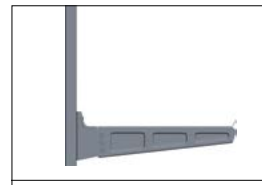

Mounting Cantilever arm 50i on pendant 2F/2FB with t-bolt.

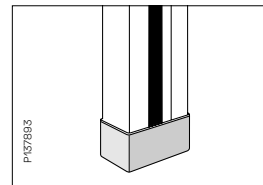

High visibility end plug for enhanced safety and provide protection against personal injury.

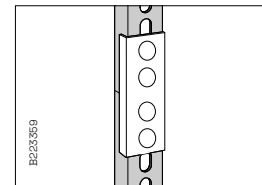

Vertical piece 2F can be joined to achieve the required length using Pendant/fixing rail 24/48 and Pendant joint 2FJ.

Breaking load symmetrical loading*

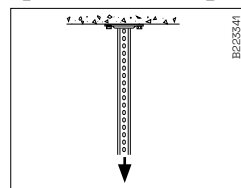

Breaking load for Vertical piece 2F (VP) = 2300 kg (23 kN) at symmetrical loading.

VP + Pendant bar for reduction of deflection

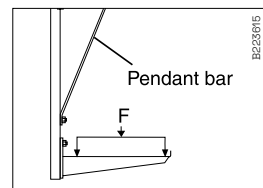

Deflection of Vertical piece 2F is reduced by installing Pendant bar 1. Loadings in accordance with chart below.

Technical information

Use and installation

Breaking load asymmetrical loading

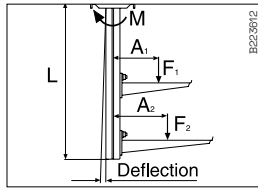

$M = \sum F \times A$
See also max loading for Cantilever 50i.

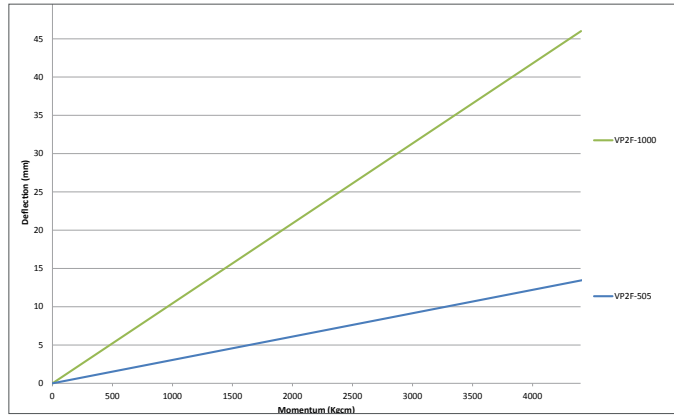

For values outside diagram please contact Wibe Group.

Example

- Conditions:
- 2 m support distance.
 - 10 kg/m cantilever arm 50i
 - Two cantilever arm 50i, 200 and 300 mm
 - One-side loading
 - VP 2F//505
 - Bending?

$$M = \sum F \times A \text{ (kgcm)}$$

$$M = 10 \times 2 \times \frac{(25 + 2.6)}{2} + 10 \times 2 \times \frac{(35 + 2.6)}{2}$$

$$\quad (F_1) \quad (A_1) \quad (F_2) \quad (A_2)$$

M = 704 kgcm - bending as per diagram, about 2 mm.

Bending torque M is total sum of $F \times A$ (kgcm).

F = Cantilever arm 50i loading (kg)

F = Loading (kg/m) x support distance (m).

A = Distance between loading and VP external side (cm)

$A = \frac{\text{Ca 50i width} + 2.6}{2}$

L = VP length

Break load torque 6 000 (kgcm)

Loading table for Vertical piece 2F installed as a cantilever arm

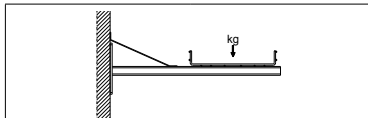

Vertical piece 2F with Pendant bar 1/500

Pendant type 2F/1000	
Mesh tray width	Breaking load
120	75
220	80
320	90
420	100
620	120

*Safe working load according to IEC 61537 is breaking load divided by 1.7.

Technical information

Use and installation

Vertical piece 2FB

Vertical piece, to be used for vertical installation together with Cantilever arm 50/50i, from a ceiling or on a floor. Can also be installed as a cantilever arm on a wall.

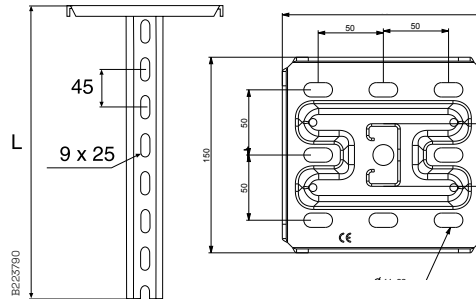
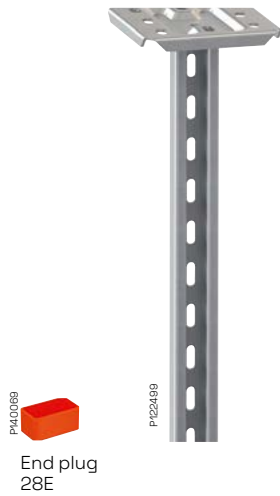

Type	L mm
Vertical piece 2FB/280	280
Vertical piece 2FB/505	505
Vertical piece 2FB/1000	1000

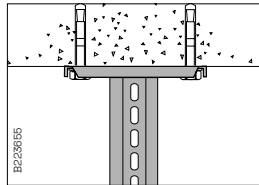

Mount Vertical piece 2FB using Expansion bolt.

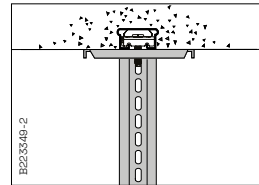

On fixing rail for casting-in, mount Vertical piece 2FB using T-bolts.

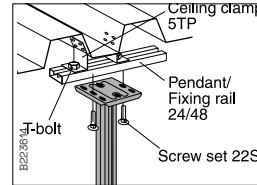

In ceilings with trapezoidal profile sheeting, mount Vertical piece 2FB as shown above

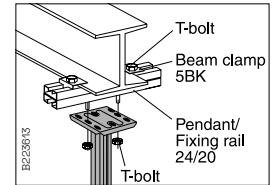

On beams in ceilings, mount Vertical piece 2FB as shown in the figure above. When the beam flange thickness does not exceed 13 mm, use Beam clamp 5BK-10 and T-bolt 26U/40. For flange thicknesses not exceeding 30 mm use Beam clamp 5BK-30 and T-bolt 26U/50.

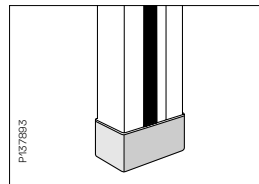

High visibility end plug for enhanced safety and provide protection against personal injury.

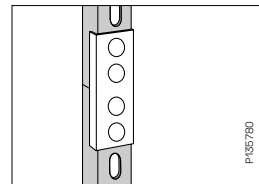

Vertical piece 2FB can be joined to achieve the required length using Pendant/Fixing rail 24/48 and Pendant joint 2FJ.

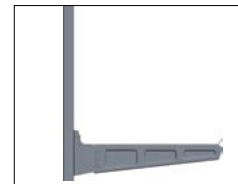

Mounting Cantilever arm 50i on pendant 2F/2FB with t-bolt.

Breaking load symmetrical loading*

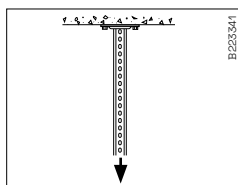

Breaking Load for Vertical piece 2FB = 3000 kg (30 kN) at symmetrical loading.

VP + Pendant bar for reduction of deflection

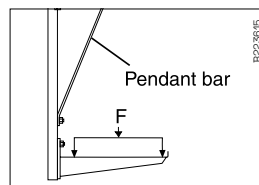

Deflection of Vertical piece 2FB is reduced by installing Pendant bar 1. Loadings in accordance with chart below.

Technical information

Use and installation

Breaking load asymmetrical loading

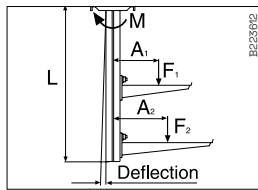

$M = \sum F \times A$
See also max loading for Cantilever 50i.

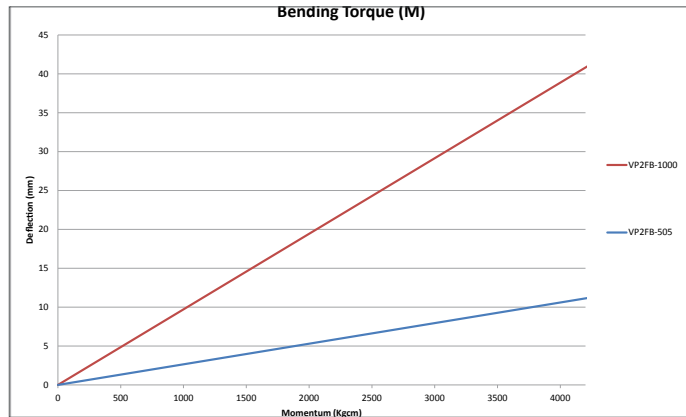

For values outside diagram please contact Wibe Group.

Example

- Conditions:
- 2 m support distance.
 - 10 kg/m cantilever arm 50i
 - Two cantilever arm 50i, 200 and 300 mm
 - One-side loading
 - VP 2F/505
 - Bending?

$$M = \sum F \times A \text{ (kgcm)}$$

$$M = 10 \times 2 \times \frac{(25 + 2.6)}{2} + 10 \times 2 \times \frac{(35 + 2.6)}{2}$$

$(F_1) \quad (A_1) \quad (F_2) \quad (A_2)$

M = 704 kgcm - bending as per diagram, about 2 mm.

Bending torque M is total sum of $F \times A$ (kgcm).

F = Cantilever arm 50i loading (kg)

F = Loading (kg/m) x support distance (m).

A = Distance between loading and VP external side (cm)

$$A = \frac{Ca \ 50i + 2.6}{2}$$

L = VP length

Break load torque 7 000 (kgcm)

Loading table for Vertical piece 2F installed as a cantilever arm

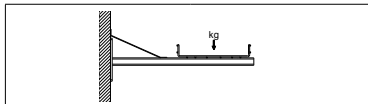

Vertical piece 2F with Pendant bar 1/500

Pendant type	2F/1000
Mesh tray width	Breaking load
120	75
220	80
320	90
420	100
620	120

*Safe working load according to IEC 61537 is breaking load divided by 1.7.

Technical information

Use and installation

Bolt and nut B13



M6x25. Tensi-Lock and Flange Nut M6. Used for mesh tray assembly with support hook B39 and various types of fitting for joining, fixing etc.

T-bolt 26U

To be used for the mounting of Cantilever arm 50 on Pendant/Fixing rail 24/48 and all vertical pieces except Vertical piece 2.

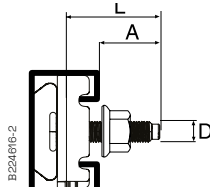

Type	L mm	A mm
M8	34	23
M10	34	23
M10	44	33
M10	54	43

Max permitted extraction force

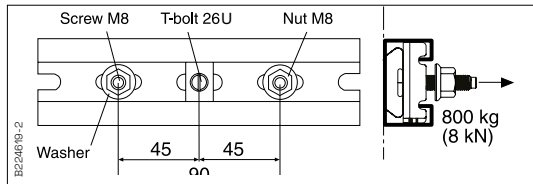

T-bolt 26U M8/M10 + P/F-rail 24/48 + Washer 8.4x19x1.5

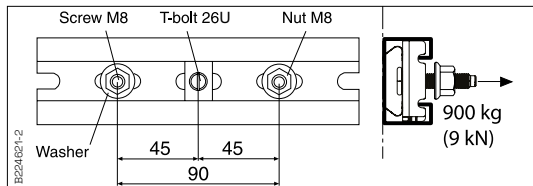

T-bolt 26U M8 + P/F-rail 24/48 + Washer 9x35x2

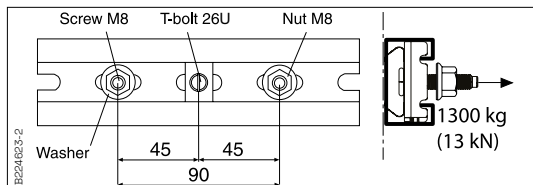

T-bolt 26U M10 + P/F-rail 24/48 + Washer 9x35x2

Screw set 2S



Screw set to be used for fastening of Support bracket 3 on Pendant/fixing rail 24/20F and Angle bracket 5L to the opening on Pendant rail 24/34 and 24/48. Set including screw MVBF 8x40 and nut M6MF8.

Screw set 20S



Screw set to be used for installation of Support bracket 3 on Pendant/fixing rail 24/20 and Vertical piece 20, Angle bracket 5L to the opening on Pendant rail 24/48 and 24/20. Set including screw MVBF 8x60 and nut M6MF8.

Screw set 22S



Screw set to be used for installation of Support bracket 3 on Vertical piece 2 and 2F, Support bracket 3 and Ceiling bracket 5 on Pendant/fixing rails 24/34 and 24/48, Angle bracket 5L against the back of Pendant/fixing rails, Pendant/fixing rails back to back. Set including screw MVBF 8x16 and nut M6MF8.

Technical information

Use and installation



Flange nut B43

Flange nut to be mounted onto Threaded rod B41 in order to lock it to the Support hook and the Ceiling fittings.
Material: Steel, electro-galvanized.



Distance nut B42

Distance nut to be used when joining Threaded rods. Screw the nut to the top rod to the middle depth of the nut. Then screw the bottom rod into the nut from below, tighten.



Thread lock B50

Thread lock to be used when joining Threaded rods. Pull the thread lock up high on the top threaded rod.



Ceiling bracket 5

Ceiling bracket to be used for installations with Pendant/Fixing rails 24/34 and 24/48.

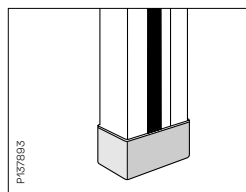
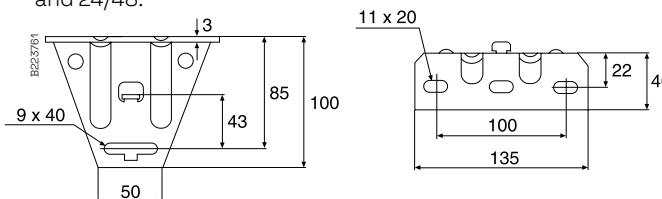

High visibility end plug for enhanced safety and provide protection against personal injury.

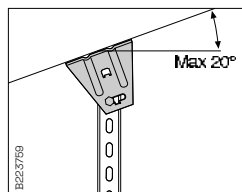

Using Pendant/Fixing rail 24/34 or 24/48, 1 Ceiling bracket 5 and 1 Screw set 22S it is possible to make a vertical piece that can be installed at an angle of up to 20°. Breaking load for rail 34 = 1000 kg (10 kN). Breaking load for rail 48 = 1200 kg (12 kN).

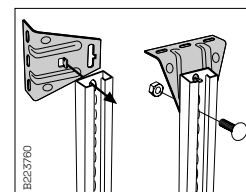

Mount Ceiling bracket 5 to the back of the pendant/fixing rail by turning the ceiling bracket 90° and inserting the tab into the hole in the rail. Then turn the ceiling bracket back and lock it in the required position using 1 Screw set 22S. When mounting it at a horizontal ceiling, lock the screw in the slot recess for better lateral stability. Ceiling bracket 5 can be tilted max. 20°.

Technical information

Use and installation

Support Hook D35/120-220

Support hook for 120-220 mm Mesh tray.

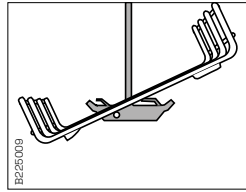
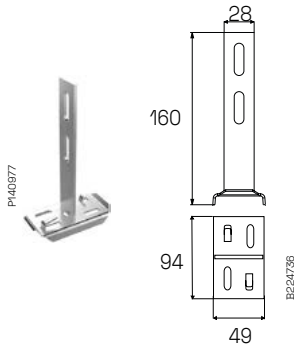

Mounted from below with angled movement.

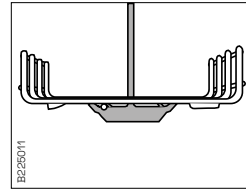

Mesh tray is mounted by closing the D35 grips.

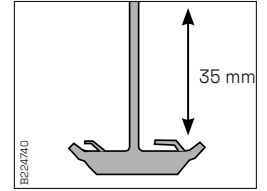

Adjustable 35 mm with Pendant 2, 2F, 2FB and Fixing rail 24/34 and 24/48.

Support Hook D35/320-422

Support hook for 320-422 mm Mesh tray.

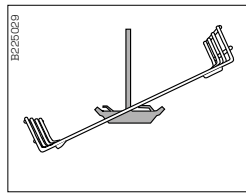
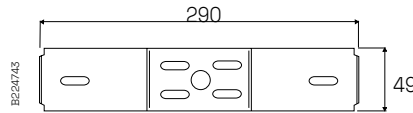
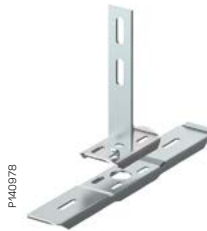

Mounted from below with angled movement and with closing of the D35 grips around the wires.

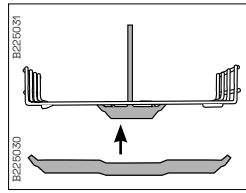

Mount the lower part of the support hook with 2 Bolt and Nut B13

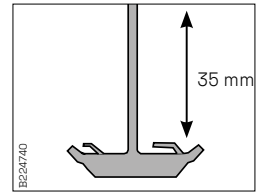

Adjustable 35 mm with Pendant 2, 2F, 2FB and Fixing rail 24/34 and 24/48.

Support Hook D35/422-622

Reinforced support hook for 422-622 mm Mesh tray.

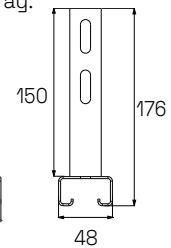
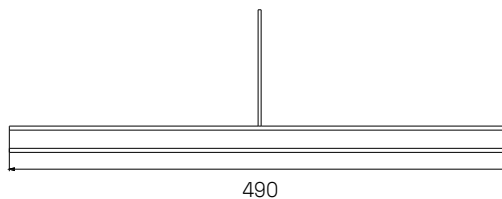

Safe Working Load (SWL)

Type of D35	kg
D35/120-220	390
D35/320-422	127
D35/422-622	370



Mount the lower part of the Support Hook with 2 Fitting B2 and 2 Bolt and Nut B13. Screw set 22S is used for installation of Support hook D35 on Vertical piece 2, 2F/2FB and Pendant/fixing rail 24/34 and 24/48.

Technical information

Use and installation

Ceiling Fitting Universal B46

For mounting of Threaded Rod B41 onto ceiling.

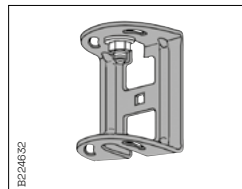
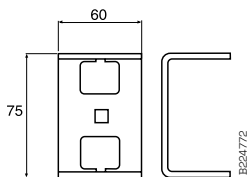
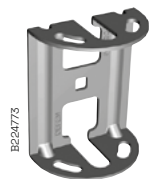

Mount the Ceiling Fitting B46 with Expansion bolt or bolt onto horizontal ceiling.

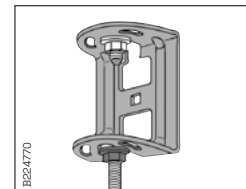

Threaded Rod B41 M8 or M10 is mounted as pendant with 2 Flange Nut B43.

Ceiling Fitting Flexible B47

Adjusts to inclination of ceiling. Delivered complete with Tensi-lock Flange Nut.

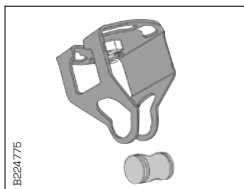
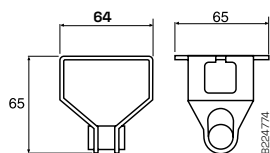
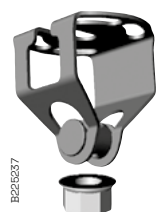

Mount the Ceiling Fitting B47 with Expansion bolt or bolt onto level or sloping ceiling.

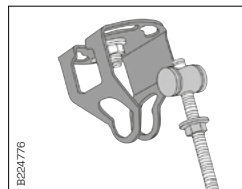

Screw in the yoke and the Tensi-lock nut onto the Threaded Rod B41.

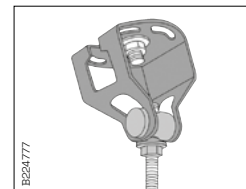

Hook the Threaded Rod onto the B47 and tighten the Nut.

Technical information

Use and installation

Ceiling Clamp B48

For hole \varnothing 22 mm. Delivered complete with Tensi-lock Nut and washers.

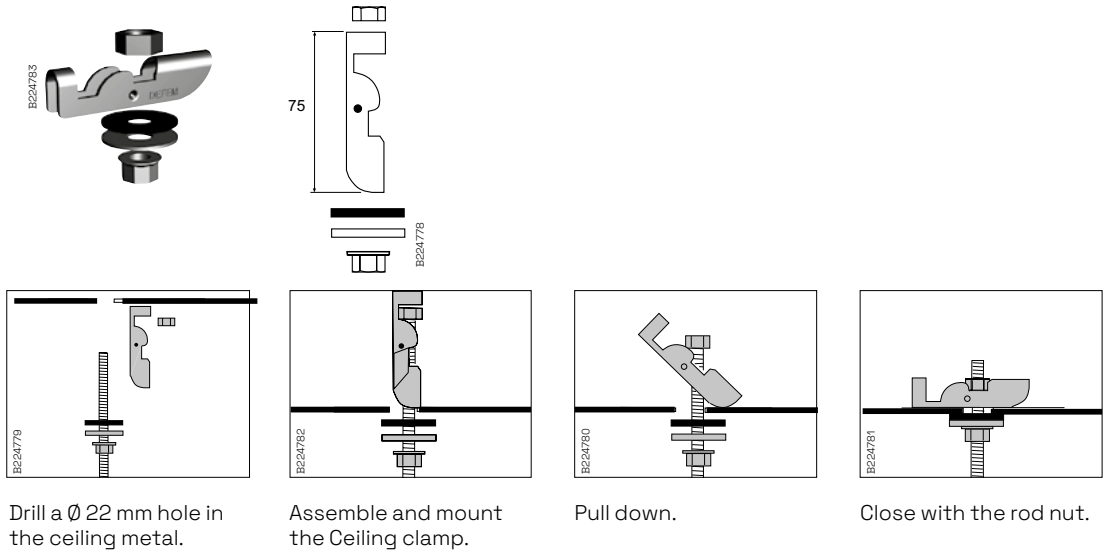

Drill a \varnothing 22 mm hole in the ceiling metal.

Assemble and mount the Ceiling clamp.

Pull down.

Close with the rod nut.

Beam Clamp B49

For mounting onto beam.

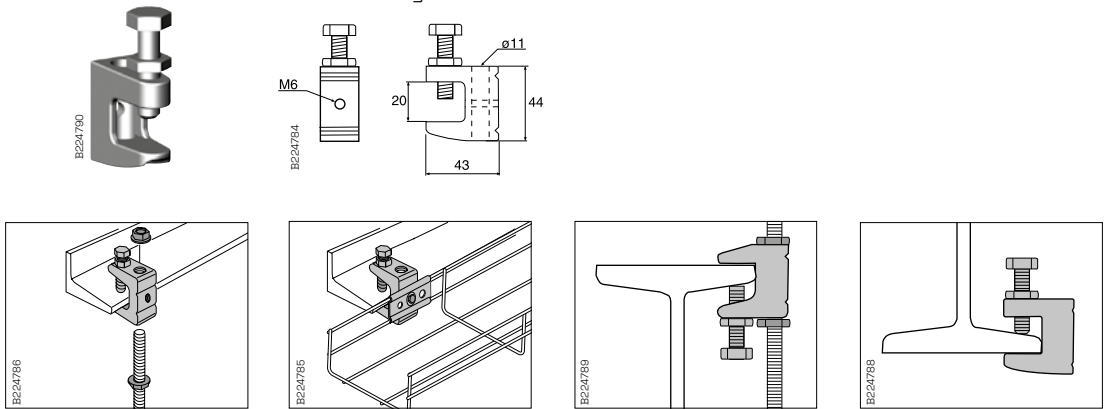

For mounting of Threaded Rod B41 with Flange Nut B43/ M8 – M10.

Mesh tray 53 –120 mm can be mounted directly onto Beam Clamp B48 with Fitting B1 and M6 bolt.

Mount the Beam Clamp with the locking bolt against the sloping side of the beam.

Technical information

Use and installation

Support Hook B39 120-220 and 320-422

Support Hook for mounting onto Threaded Rod.

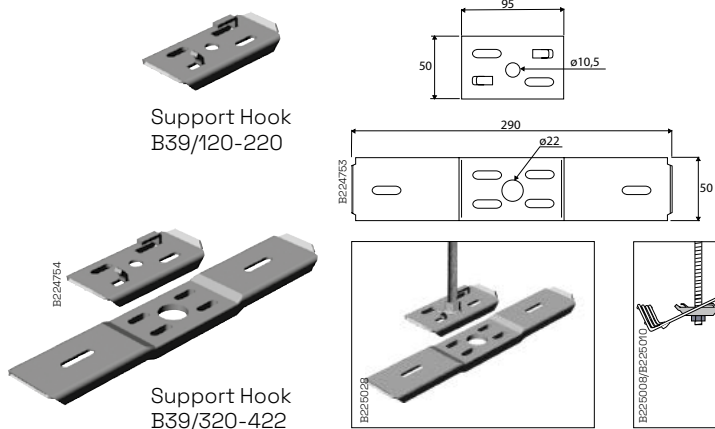

Support Hook B39/120-220

Support Hook B39/320-422

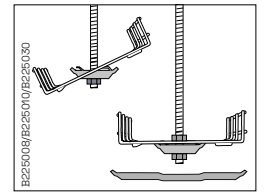
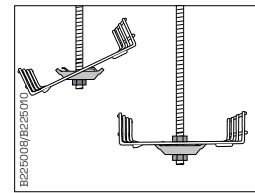
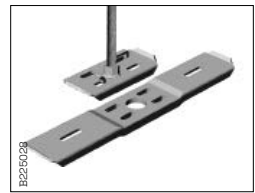

Support Hook B39 is used together with Threaded Rod B41 as pendant. Mounted with 2 Flange Nut B43.

Support Hook B39/120-220. Mesh tray is mounted from below angled movement and by closing the grips of the B39 around the wires.

Mount the lower part of B39/320-422, after mounting the Mesh tray, with 2 Bolt and Nut B13.

Threaded Rod B41 and Thread Lock B50

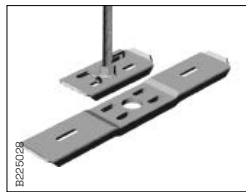

Threaded Rod B41 is mounted onto Support Hook B39 with 2 pcs Flange Nut B43.

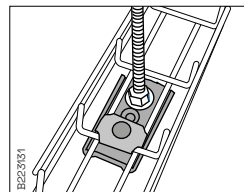

For Mesh tray 53 and 75, the Fitting B1 can be used as support hook. Mounting with 1 Fitting B1, 1 Fitting B2, 1 Bolt and Nut B13 and two Flange Nut B43.

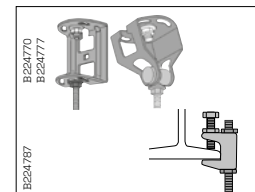

For ceiling mounting, use Ceiling Fittings B46, B47, B48 or B49.

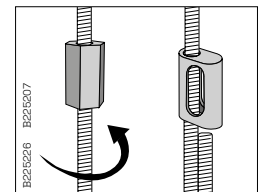

The Threaded Rod is extended by using Distance Nut B42 or Thread Lock B50 as joining fitting.

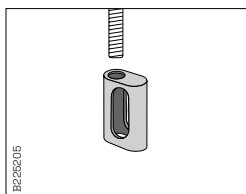

Put the Thread Lock B50 in the desired position onto the upper Rod.

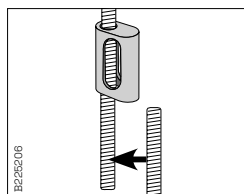

Put the lower Rod in contact with the upper Rod.

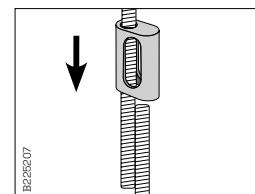

Lower the Thread Lock B50 onto both rods, now in locked position.

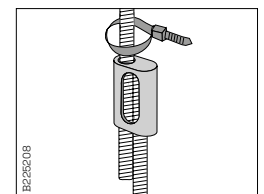

Put a cable stripe above the upper Thread Lock as safety lock.

Flange Nut B43, M8/M10 and Distance Nut B42

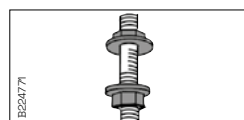
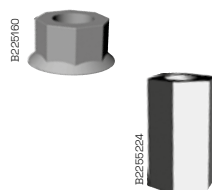

Flange Nut B43 is mounted onto Threaded Rod B41 in order to lock it to the Support Hook and the Ceiling Fittings.

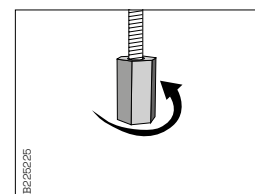

Screw in the Distance Nut on the upper Threaded Rod to the middle.

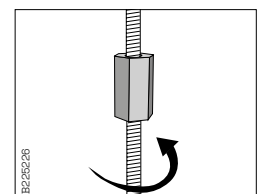

Screw in the lower Threaded Rod into the Distance Nut and tighten.

Technical information

Use and installation

Accessories Holder B5 Mini

Fits to all Mesh trays.

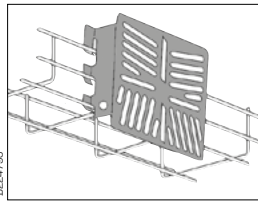
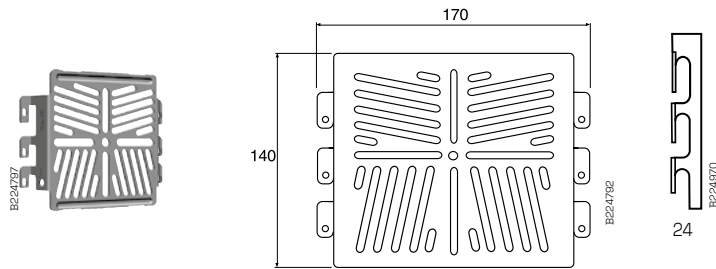

Accessories Holder B5 Mini is easily mounted directly on the side of the mesh tray.

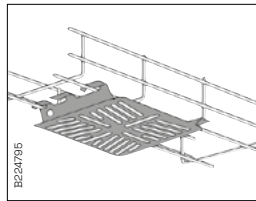

Accessories Holder B5 Mini is mounted equally easy to the bottom of the mesh tray.

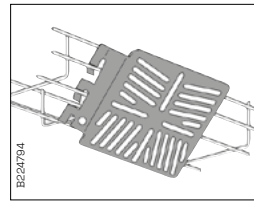

Accessories Holder B5 Mini is also mounted in 45° angle onto the mesh tray.

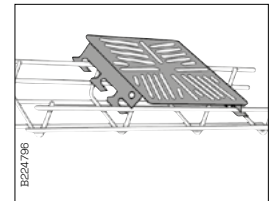

Accessories Holder B5 Mini can also be mounted on top of the 53 and 73 mesh trays.

Accessories Holder B5

For Electro-galvanized and Hot dip galvanized

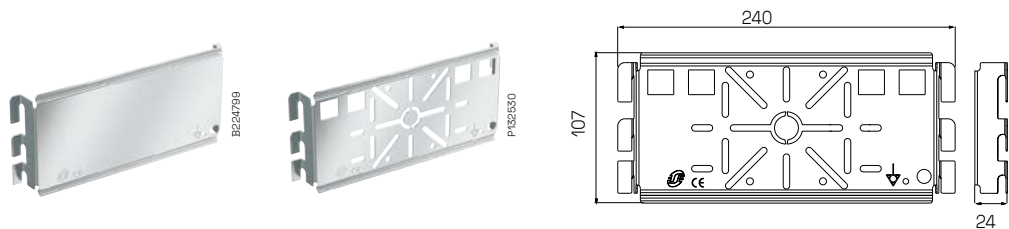

For AISI 316L

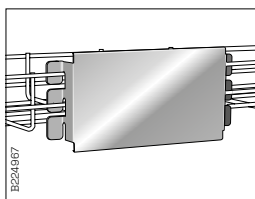
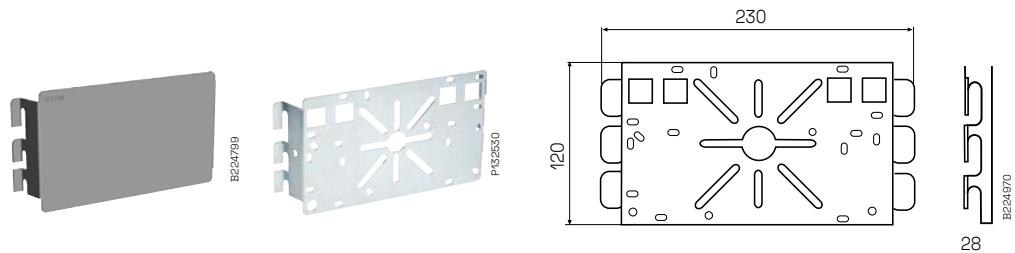

Accessories Holder B5 is easily mounted directly on the side of the mesh tray.

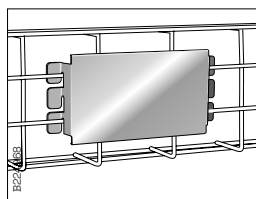

Accessories Holder B5 is mounted equally easy to the bottom of the mesh tray.

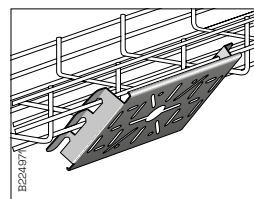

Accessories Holder B5 is also mounted in 45° angle onto the mesh tray.

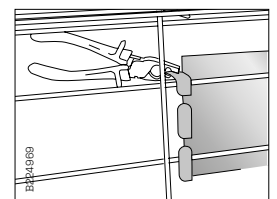

Accessories Holder B5 is tightened to the mesh tray by closing the grips around the wires.

Technical information

Use and installation

Plate Cover B7

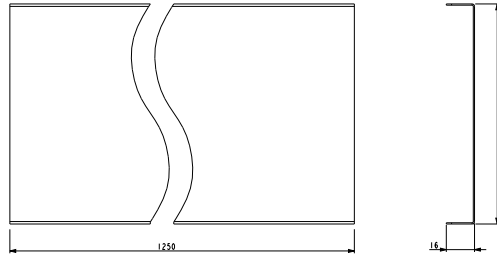

	For tray width mm	A mm
Plate Cover B7/75	75	80
Plate Cover B7/120	120	125
Plate Cover B7/220	220	225
Plate Cover B7/320	320	325
Plate Cover B7/422	422	425

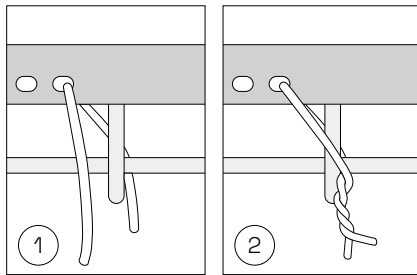

For outdoor use the lashing wire HT-2303 (713686) or HT-2313 (713687) to lock the cover in each corner.

- 1) Insert the lashing wire in the oblong hole.
- 2) Pass the wire around the longitudinal wire and cross the next transversal wire. Twist and tight the wire with at least 3 loops.

For vertical use; An additional wire can be use in middle of the cover sides.

Spring Cover Clip B8

Spring clip used to fix B7 cover to the DEFEM mesh tray.
Note! Horizontal installation only. For vertical installation consult Wibe Group for advice.

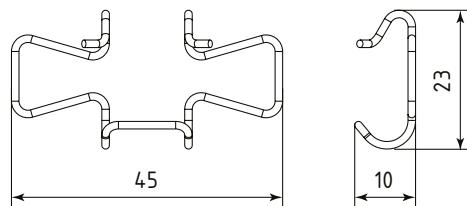

It is recommended to use a minimum of 4 clips per cover.



Thread the first wire hook in one hole.

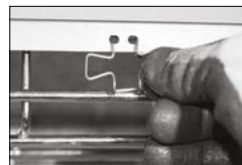

Compress and insert the second wire hook in the other hole.

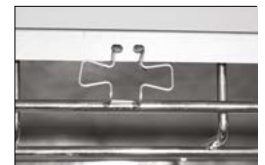

The spring is now secured in the tray and does not fall off.

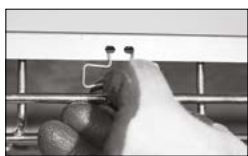

Gently stretch the clip downwards to allow the hook to pass over the horizontal wire.



Push inwards to lock the clip on the wire. Pull outwards to unlock the clip.



The cover can be opened and closed as preferred for maintenance and easy access.

Technical information

Use and installation

Separating Plate B36

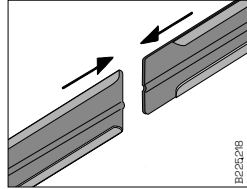
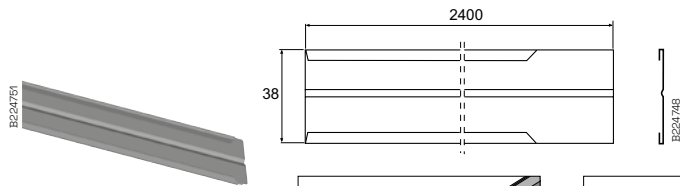

Simple joining by gliding Plates into each other.

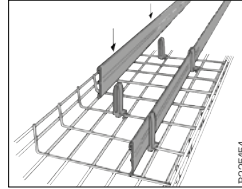
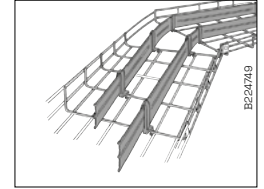

Plate Holder B38 is used for mounting of Separating Plate B36 onto Mesh tray.



The Separating Plate B36 can be shaped to follow the horizontal bends of the mesh tray.

Plate Holder B38

Used for mounting of Separating Plate B36, 5 pcs/Separating Plate.

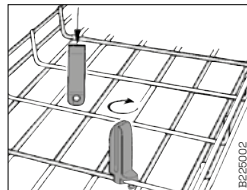

The Plate Holder is easily turned into fixed position on the mesh tray.

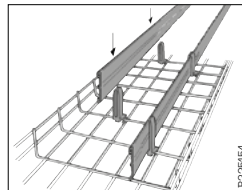

Separating Plate B36 is snapped into the Plate Holder.

Technical information

Use and installation

Separating Plate B26

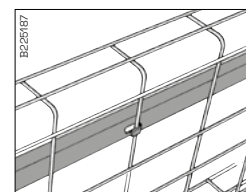
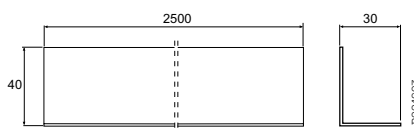
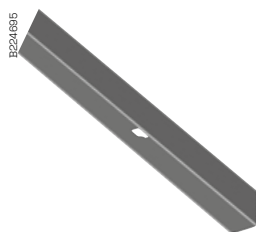

Use the grips of the Separating Plate B26 to attach to the cross wires of the Mesh tray.

Tele-Channel B6

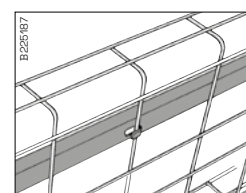
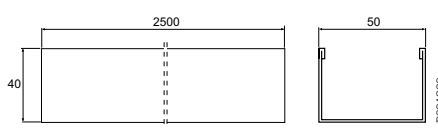
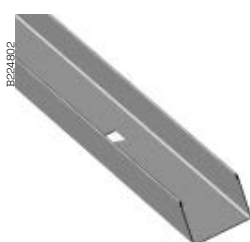

Use the grips of the B6 Tele-channel to attach to the cross wires of the Mesh tray.

Combi Fitting B21

For mounting onto Wibe Cable Ladders.

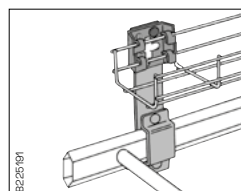
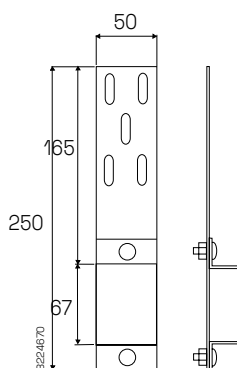

Mesh tray 53 and 75 is mounted onto Combi Fitting B21 with Bracket B4 mini Bolt and Nut B13.

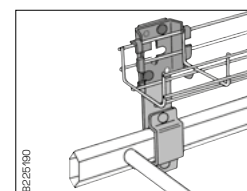

Mesh tray 120 is mounted onto Combi Fitting B21 with Bracket B4 Bolt and Nut B13.

Combi Fitting B21 90 degree

For mounting onto Wibe Cable Ladders.

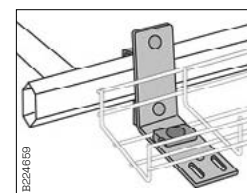
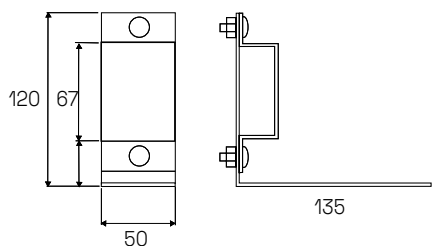
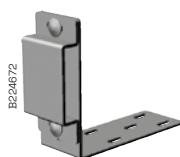

Mesh tray 53, 75 and 120 is mounted onto Combi Fitting B21 90° with 1 Fitting B2,1 Bolt and Nut B13.

Technical information

Use and installation

Support B33

For mounting of all Mesh trays on floor, for example under raised floor.

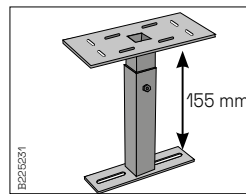
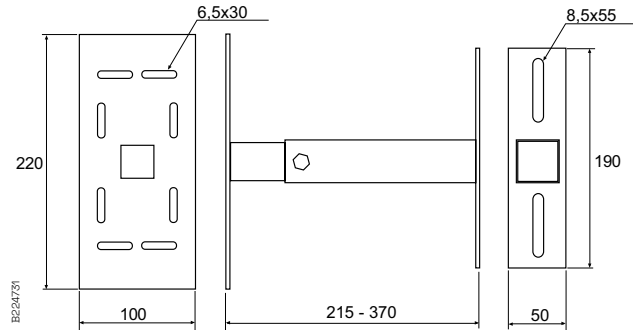
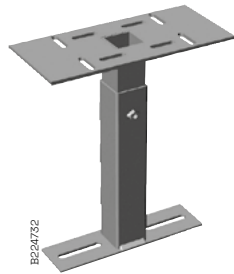

B33 Support is adjustable in height from 215 to 370 mm.

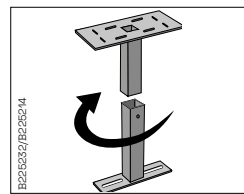

Upper or lower part can be adjusted in 90° angle.

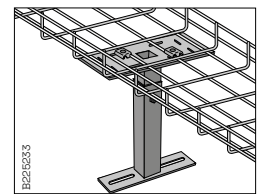

Mesh tray is mounted with suitable number of Fitting B2, Bolt and Nut B13.

Conveyor Bracket B17

Universal fitting for mounting of mesh trays along conveyor system.

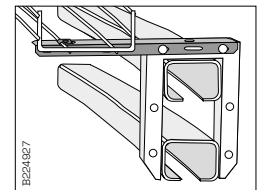
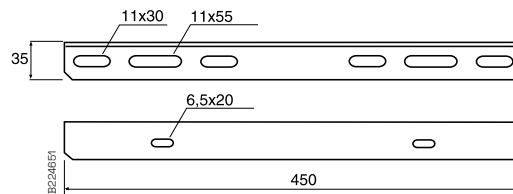
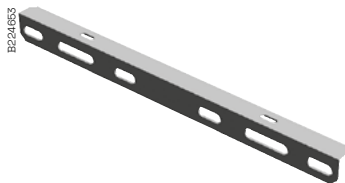

The Mesh tray is mounted onto the Conveyor Bracket with 1 Fitting B2, 1 Bolt and Nut B13.

Earth Connection Clamp B18

For mounting of earth cable onto chosen wire in the Mesh tray.

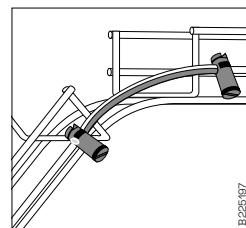

Earth connection clamp B18 is mounted to connect earth cable to mesh tray.

Technical information

Use and installation

Bend Plate B31

For smooth cable bend at change of level.

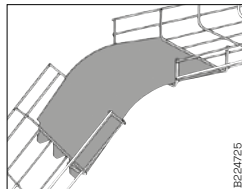
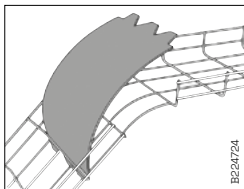
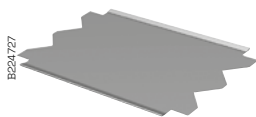

Attach the Bend Plate ends into the lower part of the Mesh tray.

Attach the Bend Plate into the upper part of the Mesh tray.

Side Radius Limiter B11

Used for limiting side bend radius of any cable type.

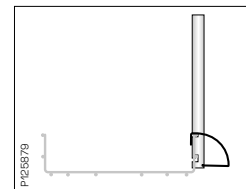
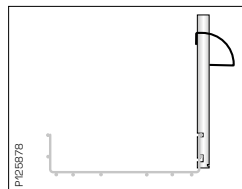
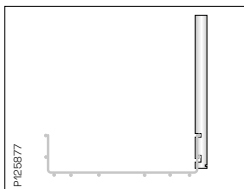
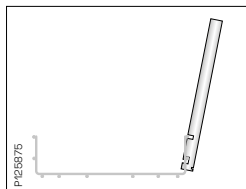
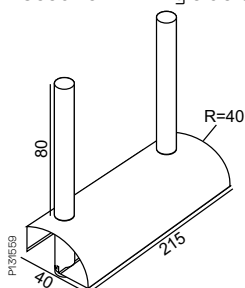
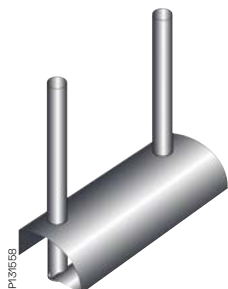

Radius Limiter B34

Limits the bend radius for sensitive cables.

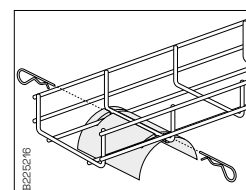
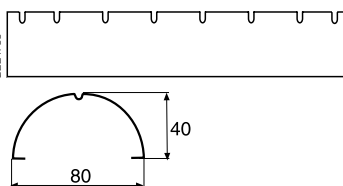
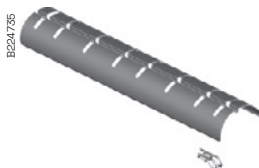

The radius limiter is mounted from below with the locking stick.

Radius Limiter B67

Limits the bend radius and gives protection at side position.

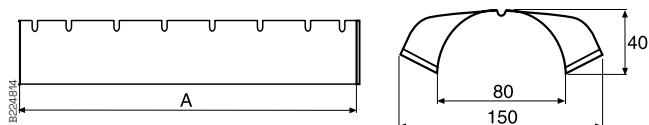
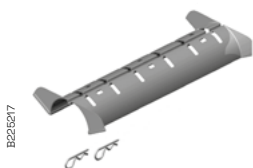

Technical information

Use and installation

Marking Clip B44

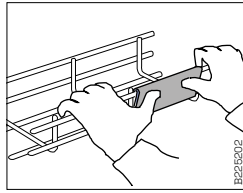

The Marking Clip is snapped onto the two side wires.

Identification Tag B40

Fits to wire Ø 5mm.

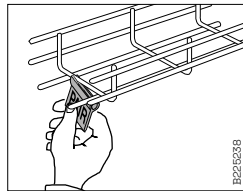
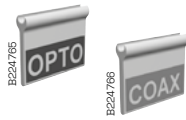

The Identification Tag is snapped onto the mesh tray.

Cable Roller B25

Facilitates the pulling of cables into the mesh trays.

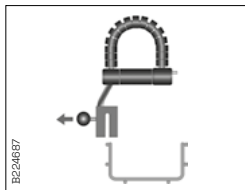
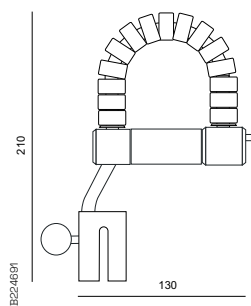

Pull the black knob outwards, place the cable roller onto the mesh tray.

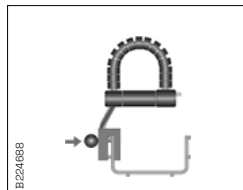

Release the black knob and the cable roller is securely mounted on the mesh tray.

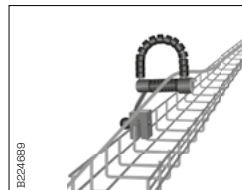

Simply pull the cable through the cable roller to the desired distance.

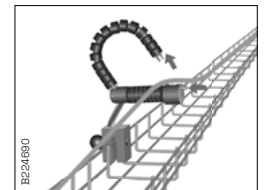

Push the small metal button to open the cable roller and place the cable in the tray.

Technical information

Use and installation

Appropriate tightening torque

Part	Application	Tightening torque (Nm)
Fitting B52	Side joint	M6: 6
Fitting B2+B13	Couplers	M6: 6
Fitting B3	Bends	M6: 6
Fitting B2+B13+Ca50i	Fitting to Ca50i	M6: 6
Fitting B27+B13	Bends/fittings	M6: 6
B46&B47+B41&B43		M8: 15/M10: 25
B41+Nut B43	Threaded rod	M8: 15/M10: 25
B41+Nut B42	Threaded rod	M8: 15/M10: 25
B48	Fitting to ceiling	M8: 15/M10: 25
B49	Fitting to beam	M8: 15/M10: 25
MCT 75+B52	Central suspension	M6: 6
T-Bolt 26U+2F+Ca50i	Support system	M8: 15/M10: 25
Screw set 2S+Pendant bar1+2F	Support system, front side of 2F	M8: 15/M10: 25
Screw set 2S+Pendant bar1+2F	Support system, back side of 2F	M8: 15/M10: 25
Screw set 20S+2F+(2)Ca50i	Balance application	M8: 15/M10: 25
Screw set 22S+2F+Ca50i	Support system, back side of 2F	M8: 15/M10: 25
2FJ+24/48	Extension application	M8: 15/M10: 25

Technical information

Mounting instructions

Connection of two trays / B1, B2, B13 alt B52

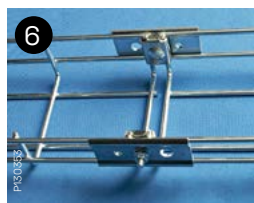

90 degree flat bends / B2

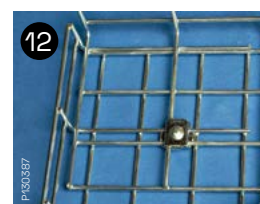
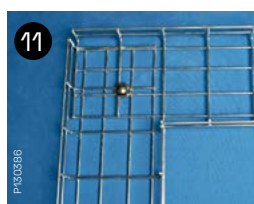
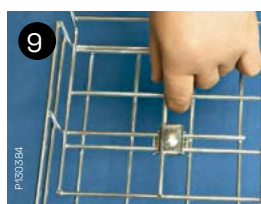
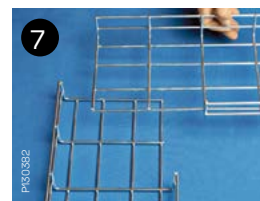
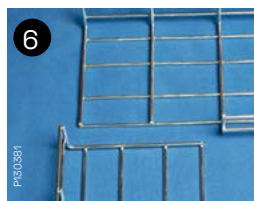
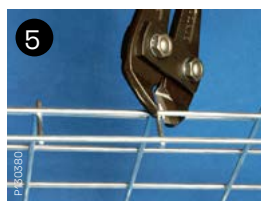
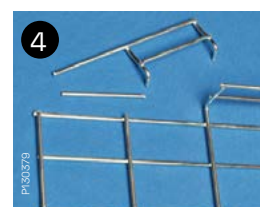
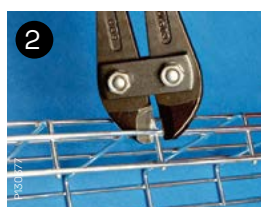

Angled flat bends / B27, B2, B13

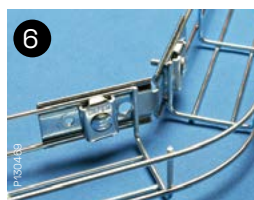
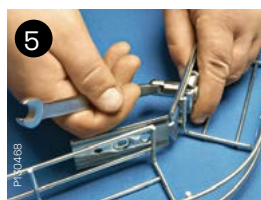
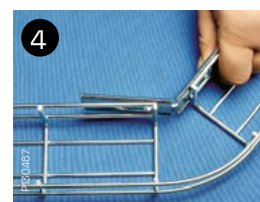
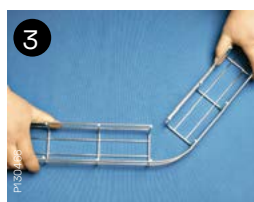
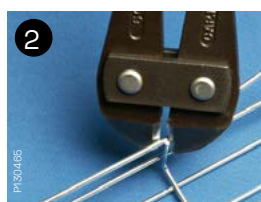

Technical information

Mounting instructions

Large radius flat bends / B3

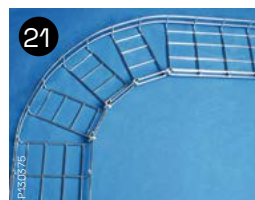
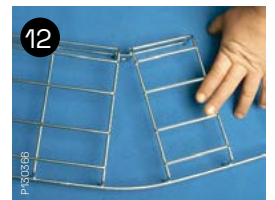
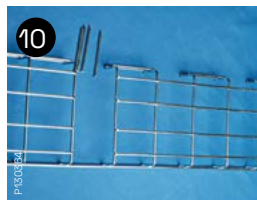
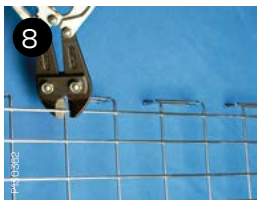
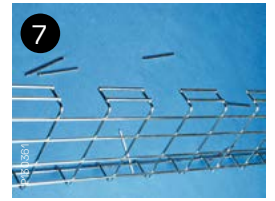
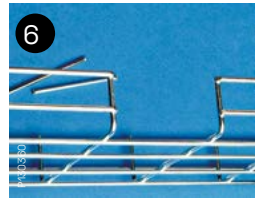
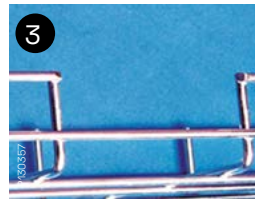

Technical information

Mounting instructions

T-junction 90 degree / B3

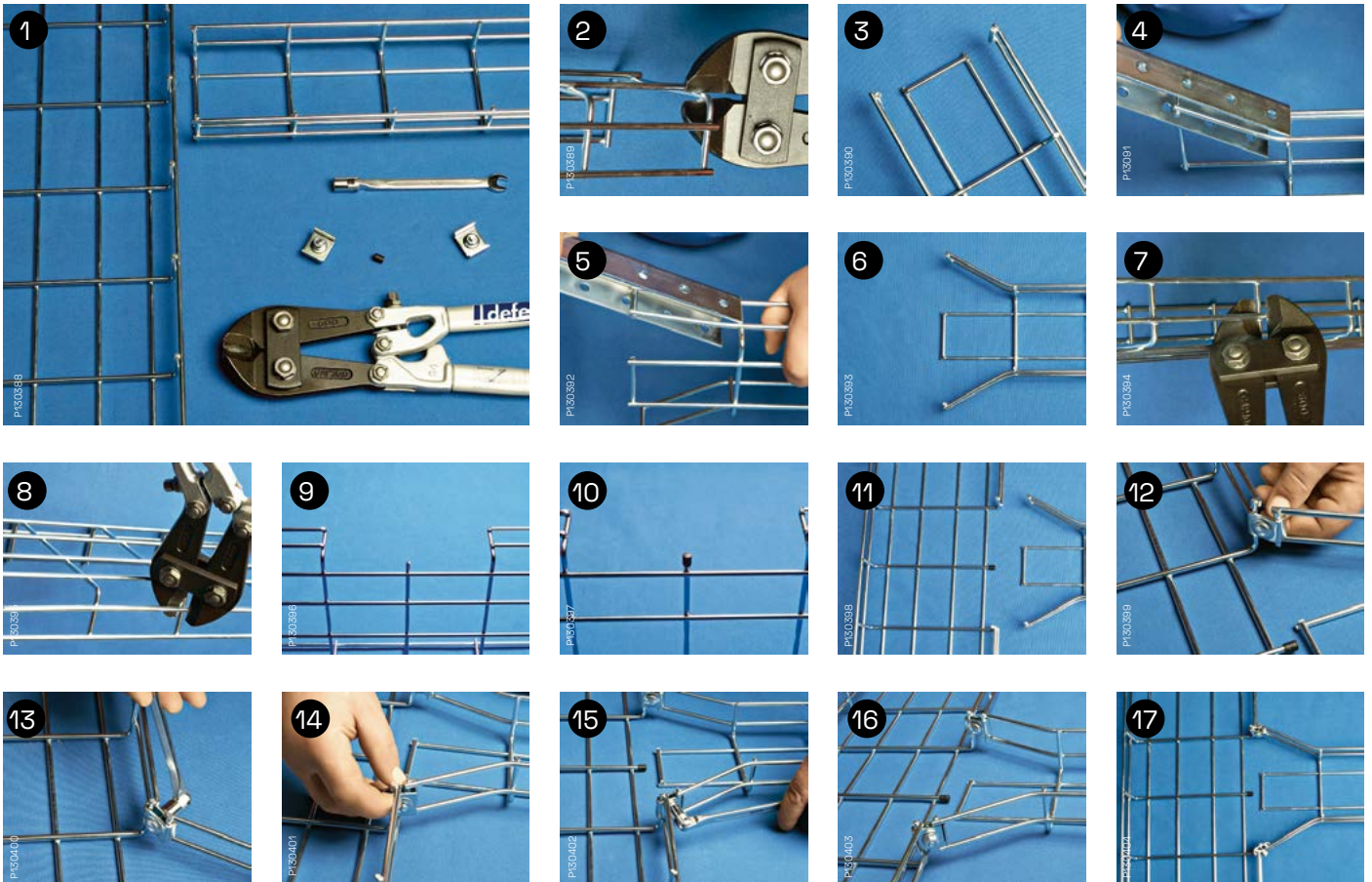
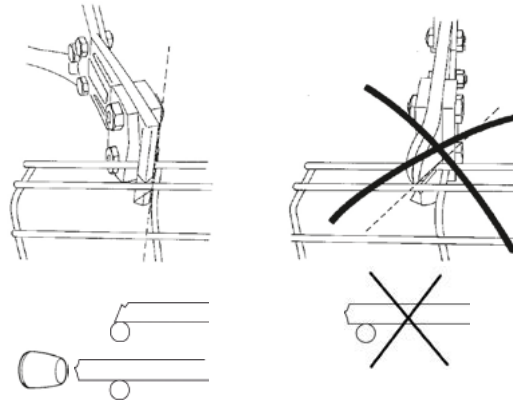

Technical information

Mounting instructions

T-junction 90 degree / B27, B2, B13



T-junction various angles / B27, B2, B13

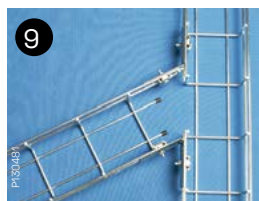
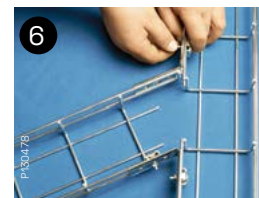
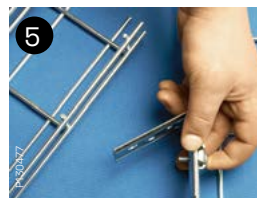
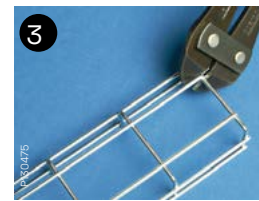

Technical information

Mounting instructions

Reducer / B1, B2, B13 alt B52

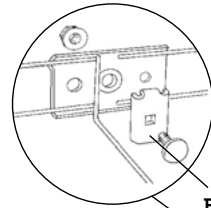
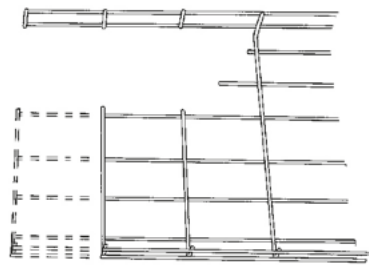
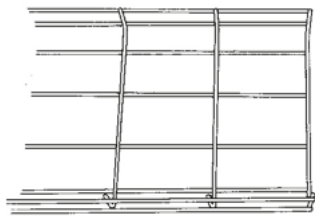

2xB1



4xB2

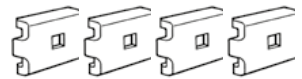

B1/B2



4xB13

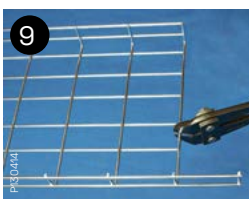
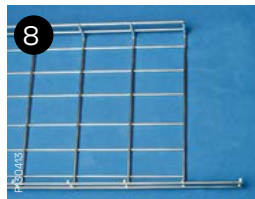
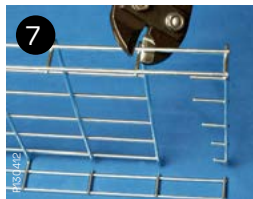
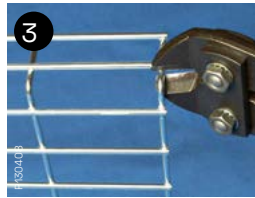
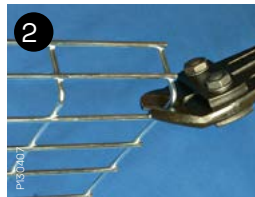
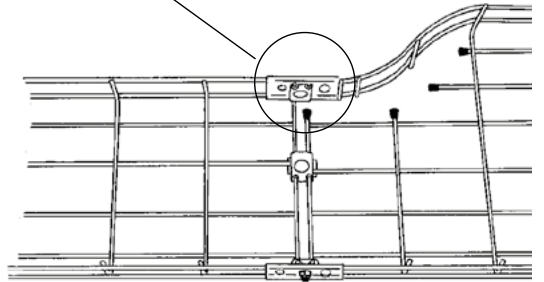

Technical information

Mounting instructions

Symmetric reducer / B1, B2, B13

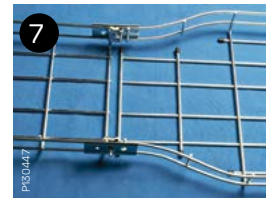
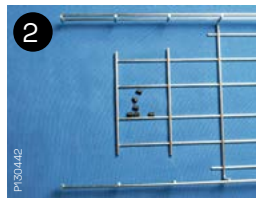
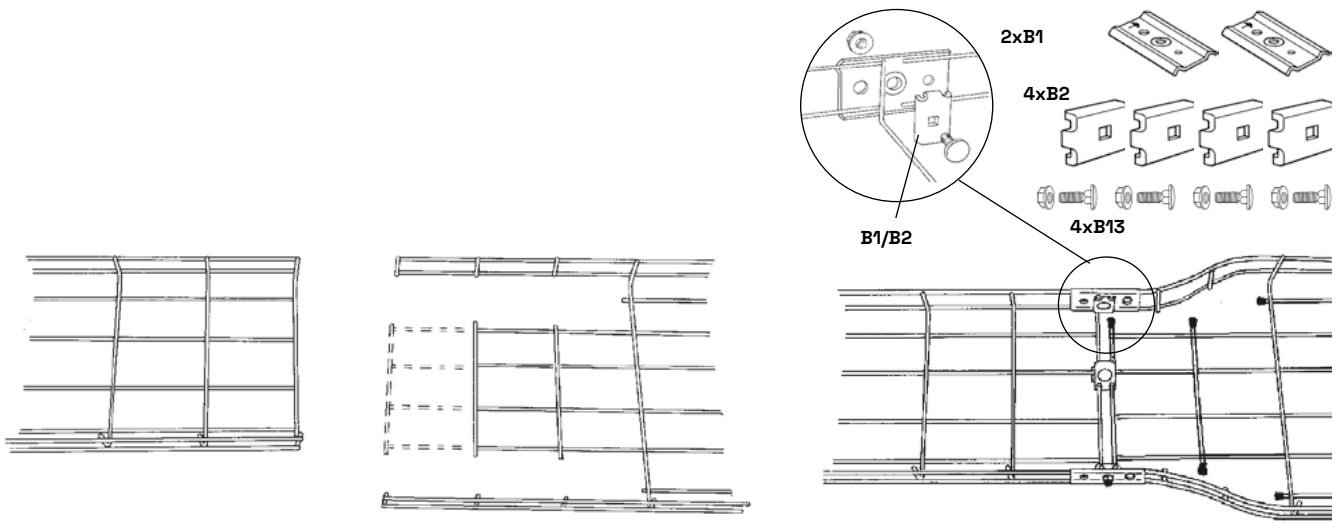

Raisers

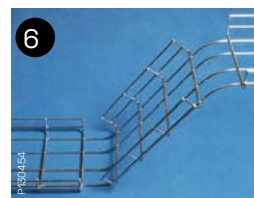
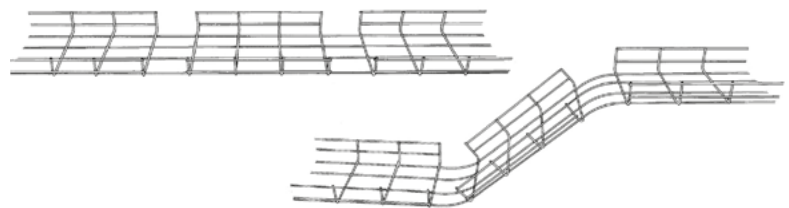

Technical information

Mounting instructions

Making an external corner / B3

