



Safety light grids and light
curtains **LCA**

EUCHNER

More than safety.

Light grids and light curtains LCA

Light grids and light curtains are non-contact safety guards (electro-sensitive protective equipment) for securing danger areas on machines and installations. They use several light beams to form an invisible safety light curtain in front of the danger area. When a machine operator interrupts one of these light beams, it will cause the safety outputs to switch off.

Non-contact safety guards are used whenever

- ▶ a machine operator must interact with the machine in very brief cycles, e.g. at loading points of automatic assembly machines.
- ▶ dangerous work areas must be secured in a continuously interlinked material flow without disturbing the material flow.
- ▶ the danger area must be secured on machines without a safety enclosure, e.g. on sheet metal processing machines, on presses, on film winding machines and on paper cutting machines.

When installed vertically, light grids and light curtains serve the purpose of access control for operating personnel. When installed horizontally, they secure areas or prevent people from stepping behind them.

■ Simple function and installation

Light grids and light curtains from series LCA consist of transmitter and receiver units that emit and receive light beams. Interrupting a light beam is the simplest and most reliable method of producing a switching signal optically without contact. The protective field size depends on the distance between transmitter and receiver (range) and its height (protective field height). The distance between the light beams constitutes the so-called resolution of the light curtain.

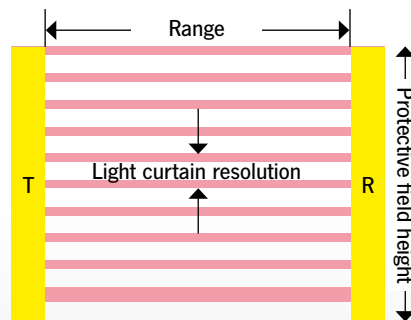

The transmitter and receiver units are installed spaced 0 to 20 meters apart on a safety fence or on supports specially designed for this purpose.

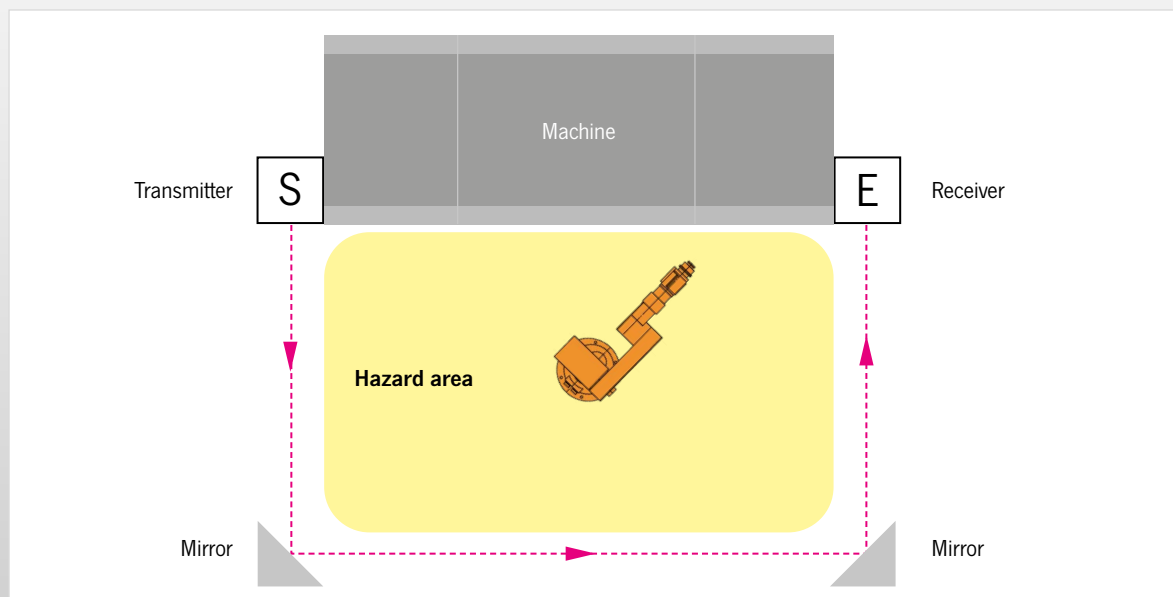

■ Light grids vs. light curtains

The basic distinction between light grids and light curtains is the number of light beams used to produce a protective field.

Light grids produce a protective field consisting of two to four light beams. Owing to the large distance between the individual light beams, light grids are particularly suitable for access control to large work areas and for applications involving a large distance between the operator and the hazardous movement.



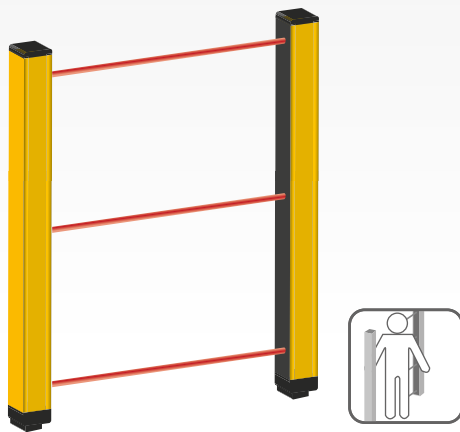

Light curtains consist of many light beams, which can detect different body parts depending on the resolution (14 – 50 mm). A distinction is made between finger, hand and body protection.

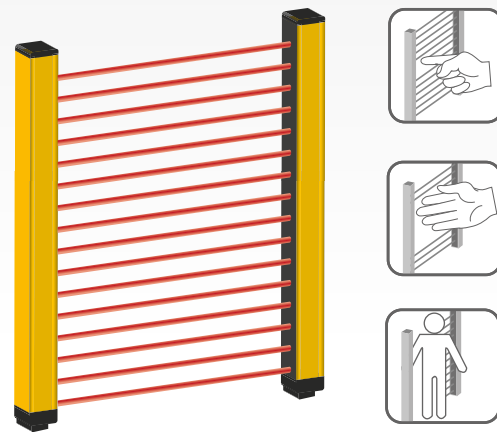

Light grid
Two to four light beams



Light curtain
Many light beams, specification as “resolution”

	Resolution/beams	Protective function	
Light curtains	14 mm	Finger protection	
	30 mm	Hand protection	
	40 mm	Hand protection	
	50 mm	Body protection (arms / legs)	
Light grids	2	Access control	
	3	Access control	
	4	Access control	

■ Protection in compliance with standards

Light grids and light curtains from series LCA meet all requirements in the relevant standards for non-contact safety guards (DIN EN 61496-1 / DIN EN 61496-2), as well as the requirements of EN ISO 13849 and IEC 62061. Category 2 / PL c or SIL 1 or category 4 / PL e or SIL 3 can be achieved depending on the type (2 or 4).

■ Distinction between type-2 and type-4 LCA devices

On type-2 devices, the safety function is checked by periodic tests. Any fault is detected during the next periodic test, and the safety outputs are switched off. Type-2 light grids and light curtains meet the requirements of category 2 / PL c and safety level SIL 1. The maximum permissible beam angle per light beam is $\pm 5^\circ$.

LCA type 2

Category 2 / PL c or SIL 1

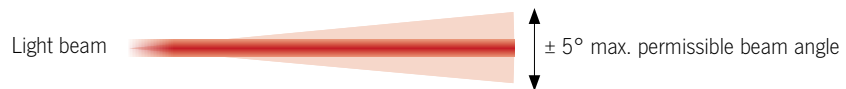

Type-4 devices can be used in applications requiring category 4 / PL e and SIL 3. They are characterized by the property of switching off a machine movement as soon as a fault occurs. Automatic restarting is prevented. The maximum beam angle per light beam is $\pm 2.5^\circ$. The beam angle of the emitted beam is only half the size here, resulting in a much higher radiation density and, above all, much higher sensor immunity to reflections from highly reflective surfaces nearby.

LCA type 4

Category 4 / PL e or SIL 3



■ Muting

Muting allows safety functions of a light grid or light curtain to be bypassed automatically for a limited time. For example, parts supplied to a dangerous area can pass through the protective field without triggering the safety function. With the aid of additional sensors, the control system monitors the proper procedure and detects whether people move through the protective field instead of the defined parts, for example. This function is simple to implement with devices from series LCA in combination with the programmable small control system MSC.



■ The cascading of light curtains

Up to three type-4 light curtains can be connected in series to secure dangerous areas. Various master/slave versions with various sizes and resolutions are available for this purpose. They can be combined with each other to implement different protective functions (finger, hand and body protection) at the same time. One frequently implemented application involves preventing people from stepping behind access protection. This ensures that nobody remains in the danger area when an installation is to be started.

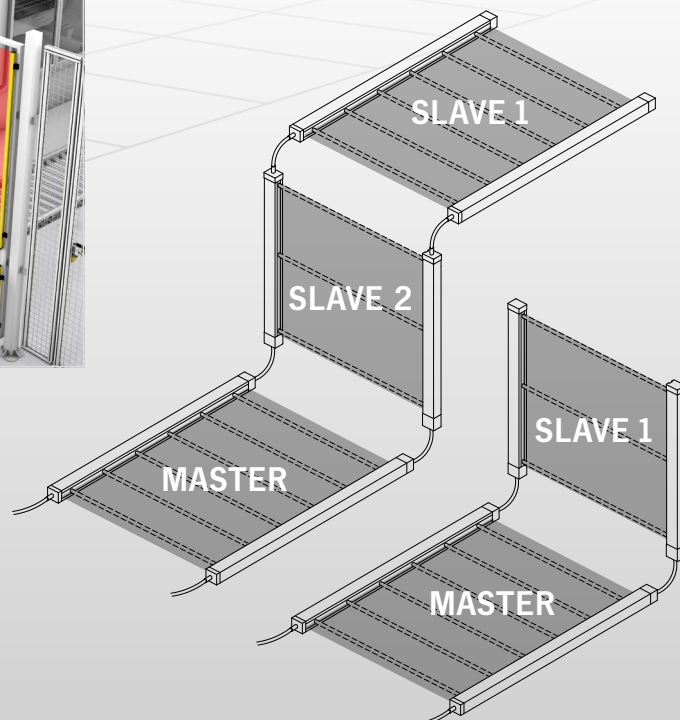

Overview of series LCA

To match different customer needs and requirements, EUCHNER offers three product families with different resolutions and protective field heights, as well as with different connection and wiring concepts:

Version LCA 2

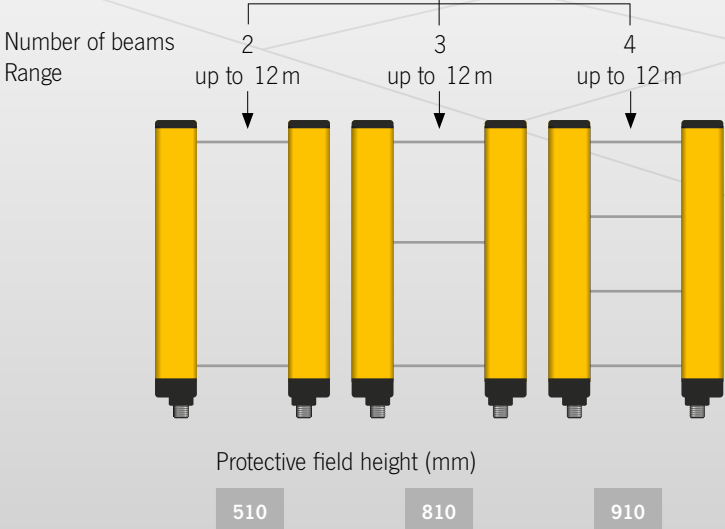
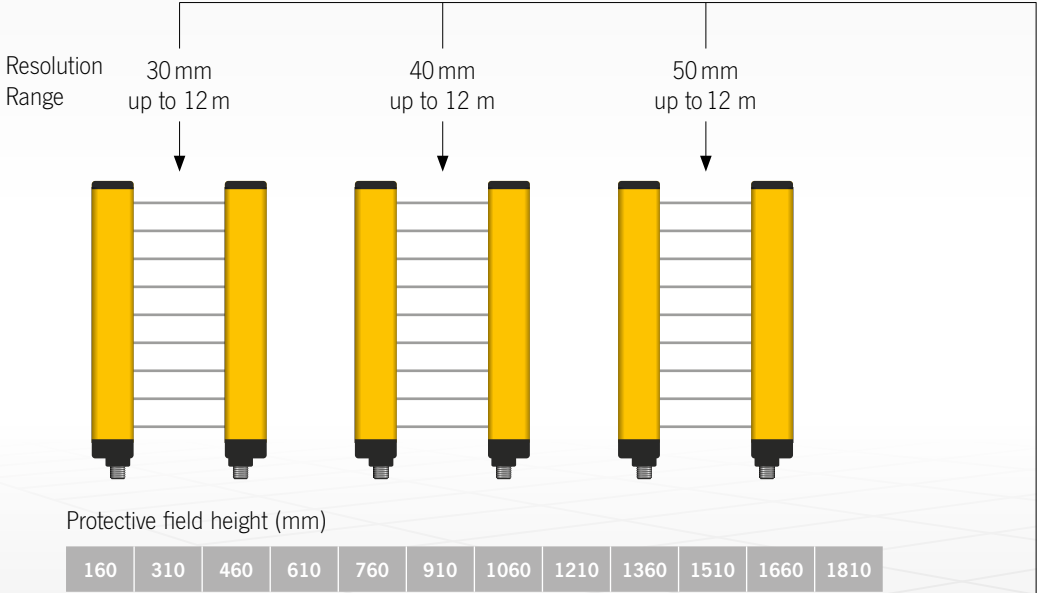
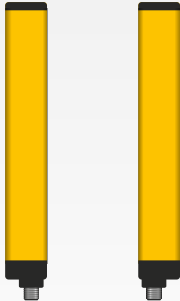

■ Version LCA 4

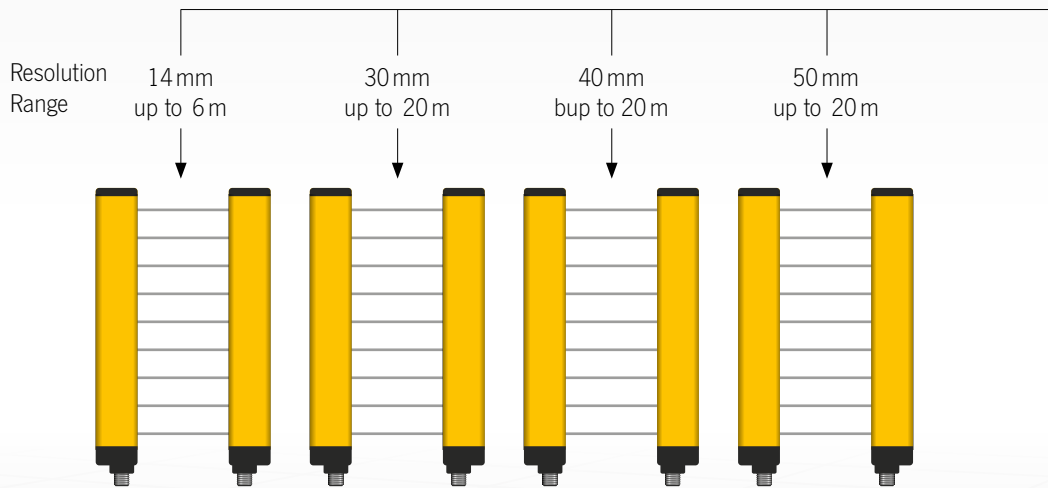
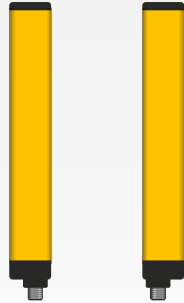

Protective field height (mm)

160	310	460	610	760	910	1060	1210	1360	1510	1660	1810
-----	-----	-----	-----	-----	-----	------	------	------	------	------	------

The versions with resolutions of 30 mm, 40 mm and 50 mm are also available with reduced range (up to 12 m).

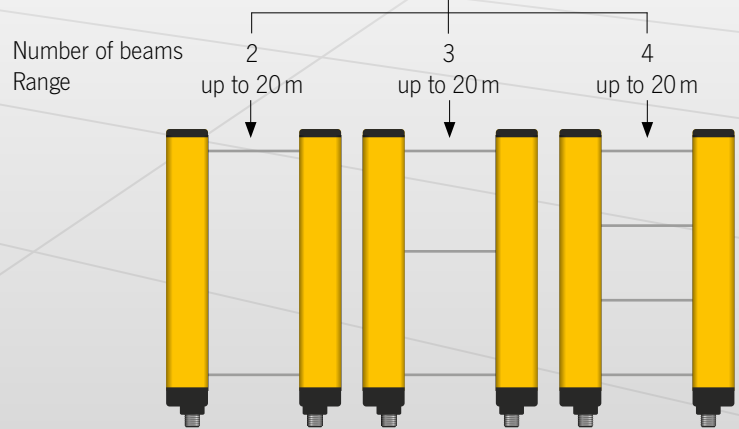

Protective field height (mm)

510	810	910
-----	-----	-----

The versions with 2, 3 or 4 beams are also available with reduced range (up to 12 m).

Overview of series LCA

Version LCA 4 MS

Up to three transmitter and receiver units, consisting of a master unit and two slave units, can be connected in series.

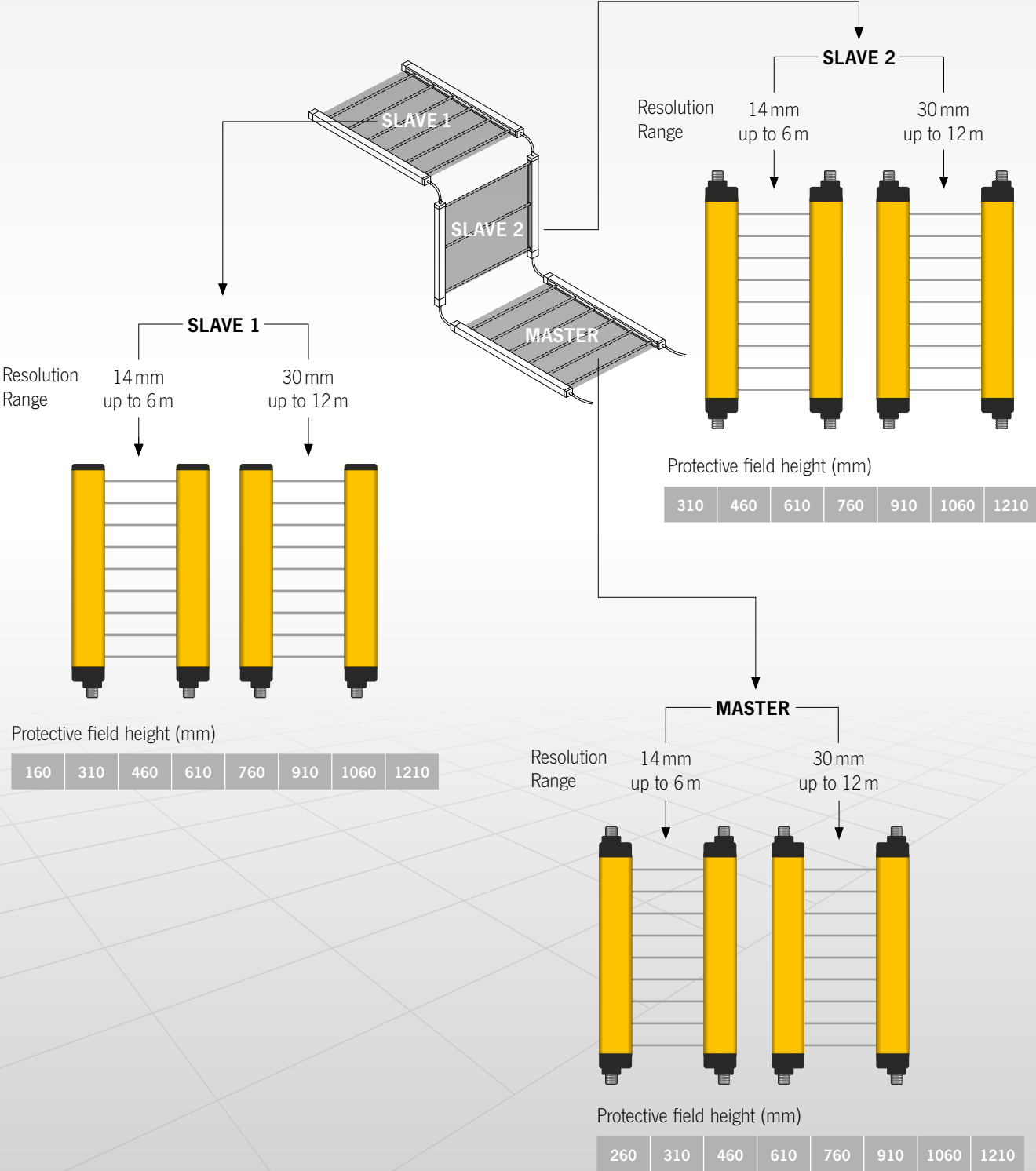

Technical data overview

Parameter	LCA 2	LCA 4	Unit	
Protective field height	160 – 1810		mm	
Resolutions	30/40/50	14/30/40/50	mm	
Number of beams (light grid)	2/3/4 beams			
Usable range (selectable)	0 – 4 (low)/ 0 – 12 (high)	Light curtains with 14 mm resolution	0 – 3 (low)/ 1 – 6 (high)	m
		Light curtains with 30/40/50 mm resolution and light grids with 2/3/4 beams	0 – 4 (low)/ 0 – 12 (high)	
		Light curtains with 30/40/50 mm resolution and light grids with 2/3/4 beams, each with extended range	0 – 10 (low)/ 3 – 20 (high)	
Type of output	2 semiconductor outputs, p-switching, short circuit-proof			
Current consumption	400		mA	
Reaction time	3 – 27	2.5 – 26.5	ms	
Test pulse length	<100		µs	
Operating voltage DC	24 ± 20 %		Vcc	
Connection	Plug connector M12 (5-/8-pin)			
Max. connectible length	100 (50 between master and slave)		m	
Operating temperature	-30... +55	Light curtains with 14 mm resolution and models with extended range	-20... +55	°C
		Light curtains with 30/40/50 mm resolution and light grids with 2/3/4 beams	-30... +55	°C
Degree of protection	IP65; IP67			
Cross-section dimensions	28 x 30		mm	
Mission time	20 years			
Reliability values according to EN ISO 13849-1				
Performance Level	PL c	PL e		
Category	2	4		
ESPE (DIN EN 61496-1/61496-2)	Type 2	Type 4		

LCA in detail



Transmitter unit diagnostic field



Receiver unit diagnostic field

► **Monitoring options:**

- Finger protection
- Hand protection
- Body protection
- Access control



► **Minimal blind area**

on the connection side

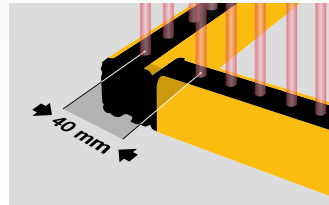

► **Feedback circuit**

to check external relays

► **Less wiring effort**

thanks to M12 plug connector

► **Ready to operate** after 2 seconds

► **No blind area**

at the end of the section





▶ **Selectable, integrated manual or automatic start/restart**

▶ **Streamlined design**, ideal for space-saving installation

▶ **IP65 and IP67**

▶ **Protective field height** from 160 mm to 1810 mm

▶ **Simple integration through hardware configuration on the plug connector**

▶ **Range** from 0 to 20 m

▶ **Individual operation or with master/slave models connectible in series**

▶ **Detailed diagnostic function** via LEDs

▶ **Integrated evaluation** of OSSD outputs

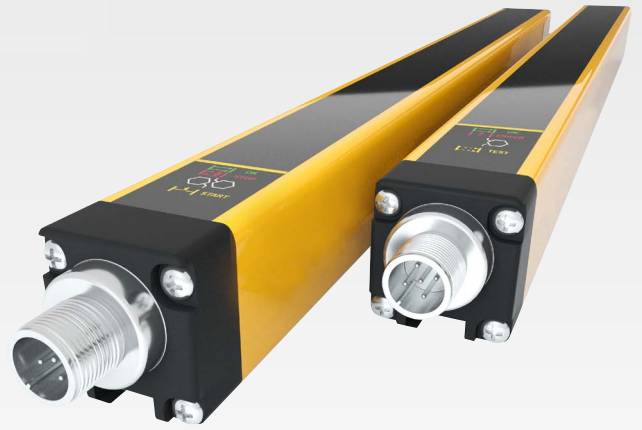

M12 connection (5-pin)



M12 connection (8-pin)

The advantages of LCA at a glance

- ▶ High level of protection against tampering
- ▶ Category 4 / PL e with only one device
- ▶ Less wiring work thanks to plug connector
- ▶ High degree of protection IP65, IP67
- ▶ Deflection mirrors permit versatile use
- ▶ Shorter access time and greater productivity through simple interaction between operator and machine
- ▶ Compact design
- ▶ Very simple setup through various start modes
- ▶ Wide product range with numerous applications



EUCHNER GmbH + Co. KG
Kohlhammerstraße 16
70771 Leinfelden-Echterdingen
Germany

Tel. +49 711 7597-0
Fax +49 711 753316
info@euchner.de
www.euchner.com

EUCHNER
More than safety.